

**SAW Filter 1575.42MHz for GPS**  
**Part No: MA05256**

**Model: TA0295A**  
**Rev No: 1**

**A. MAXIMUM RATING:**

1. Maximum Input Signal Level: 10dBm
2. Maximum DC Voltage: 5V
3. Operating Temperature: -40°C ~ +85°C
4. Storage Temperature: -50°C ~ +100°C

**B. ELECTRICAL CHARACTERISTICS:**

Item	Min.	Typ.	Max.
Center frequency Fc (dB)	-	1575.42	-
Insertion loss within Fc ± 1MHz IL (dB)	-	2.7	3.5
Amplitude ripple (p-p) within Fc ± 1MHz (dB)	-	0.07	1.0
Attenuation (Reference level from 0dB)			
1475.42MHz (dB)	35.0	40	-
1535.42MHz (dB)	30.0	37	-
1615.42MHz (dB)	30.0	60	-
1675.42MHz (dB)	40.0	62	-
VSWR within Fc ± 1MHz	-	1.3	2.0
Source impedance Z <sub>S</sub> (Ω)	-	50	-
Load impedance Z <sub>L</sub> (Ω)	-	50	-

Note: No matching network required for operation at 50Ω

**SAW Filter 1575.42MHz for GPS**  
**Part No: MA05256**

**Model: TA0295A**  
**Rev No: 1**

**C. OUTLINE DRAWING:**

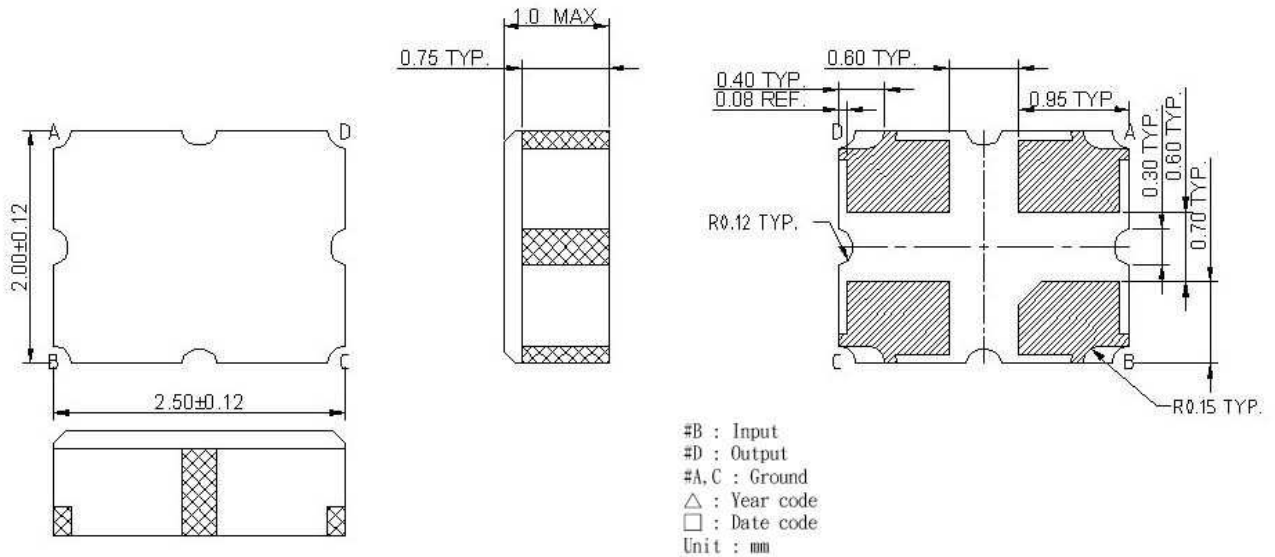

**D. MEASUREMENT CIRCUIT:**

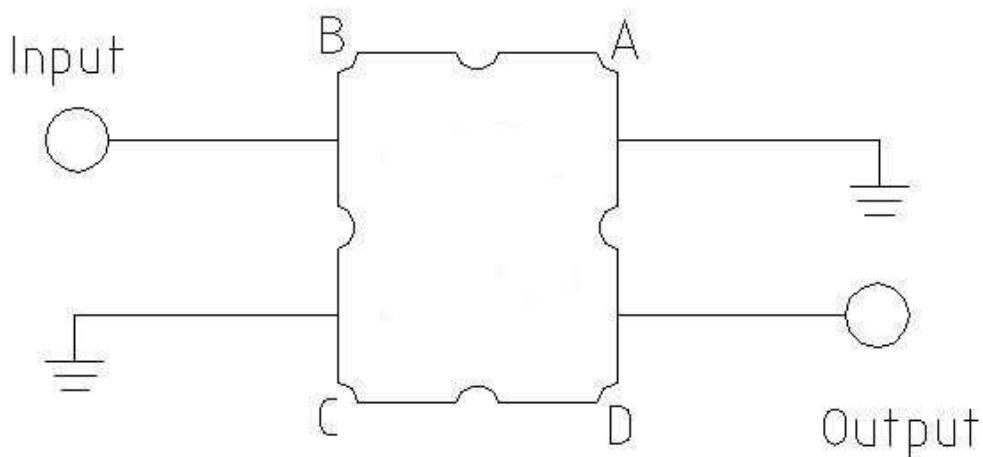

**SAW Filter 1575.42MHz for GPS**  
**Part No: MA05256**

**Model: TA0295A**  
**Rev No: 1**

**E. FREQUENCY CHARACTERISTICS:**

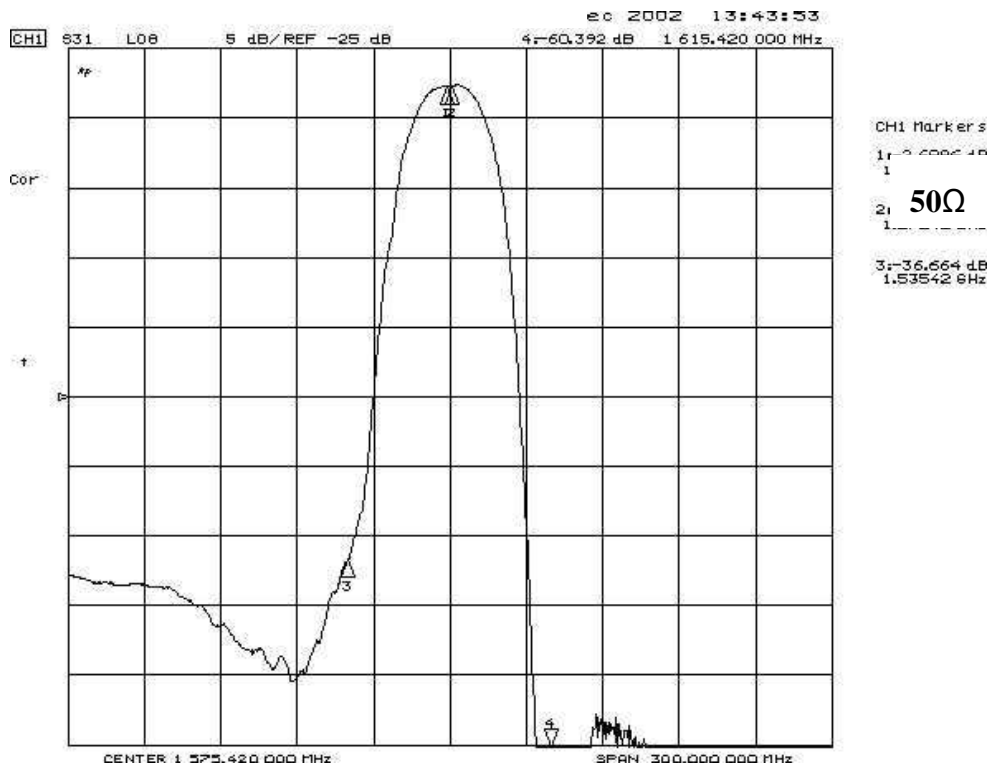

(wide band)

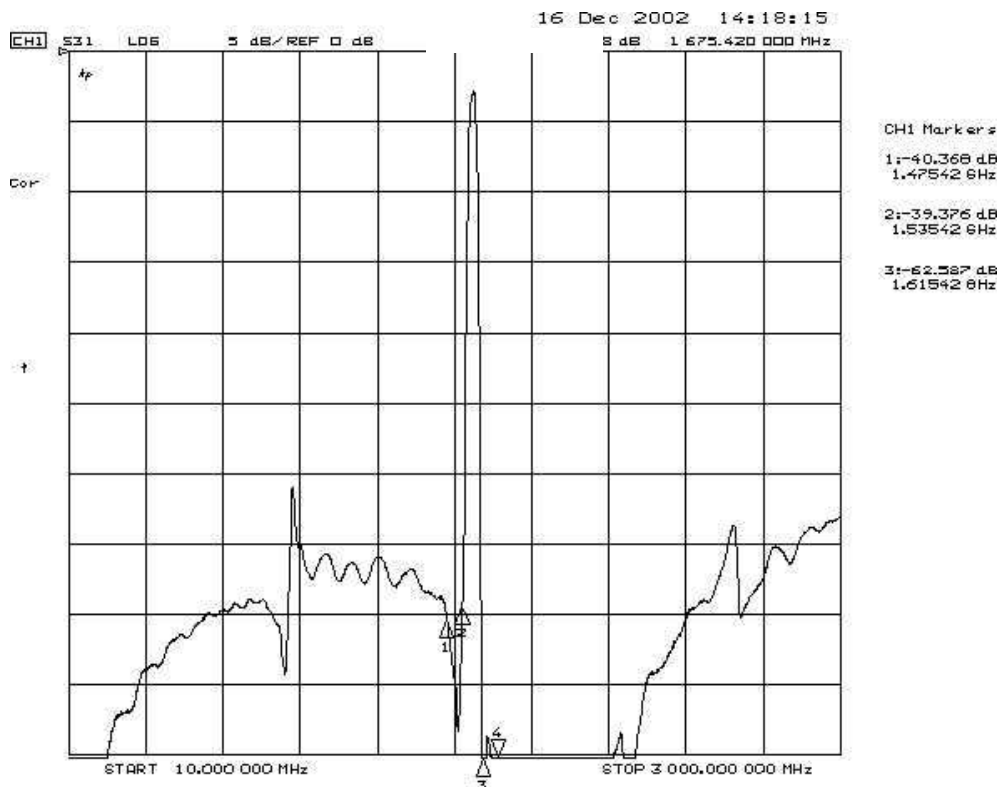

**SAW Filter 1575.42MHz for GPS**  
**Part No: MA05256**

**Model: TA0295A**  
**Rev No: 1**

Reflections Functions

S11

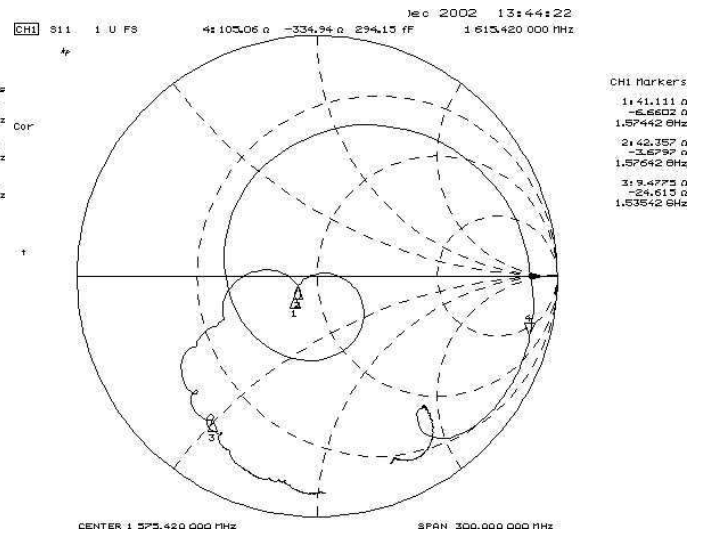
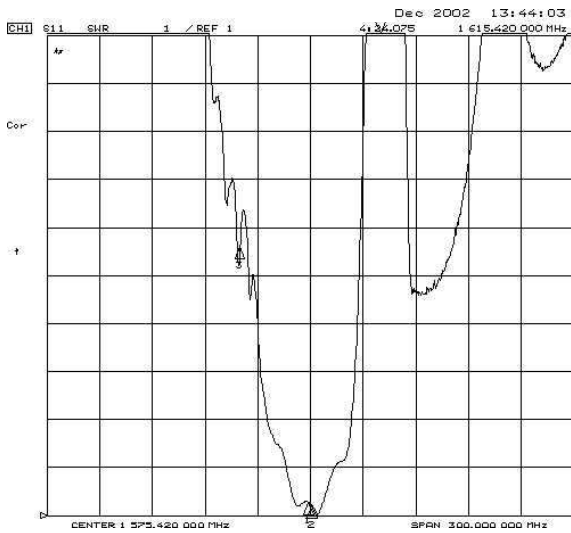

S22

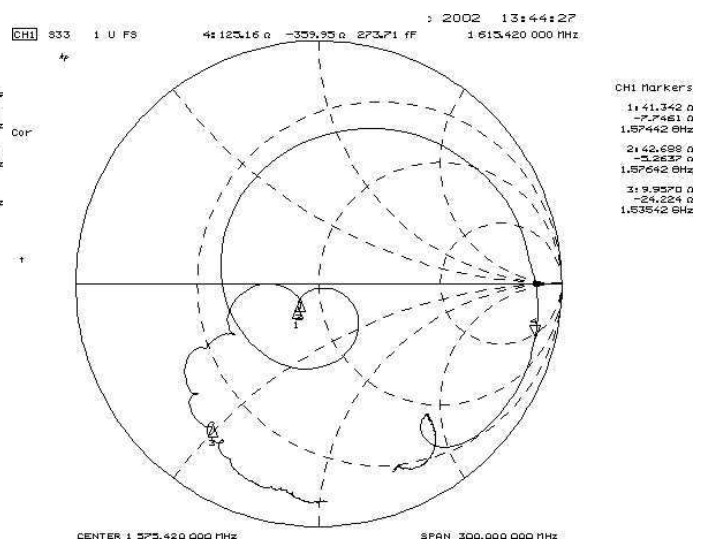
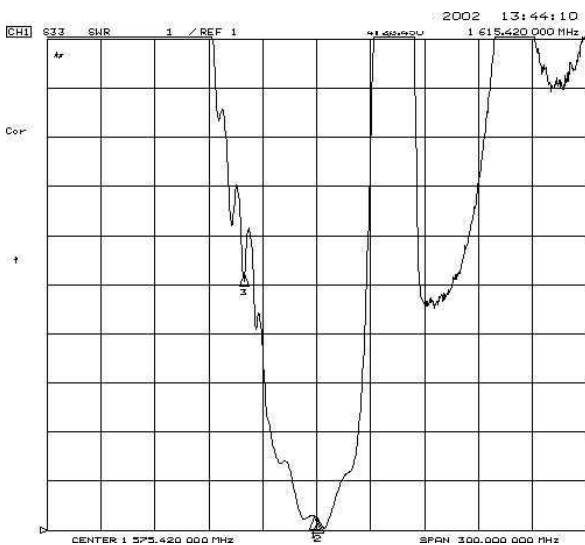

**SAW Filter 1575.42MHz for GPS**  
**Part No: MA05256**

**Model: TA0295A**  
**Rev No: 1**

**F. PACKING:**

**1. REEL DIMENSION**

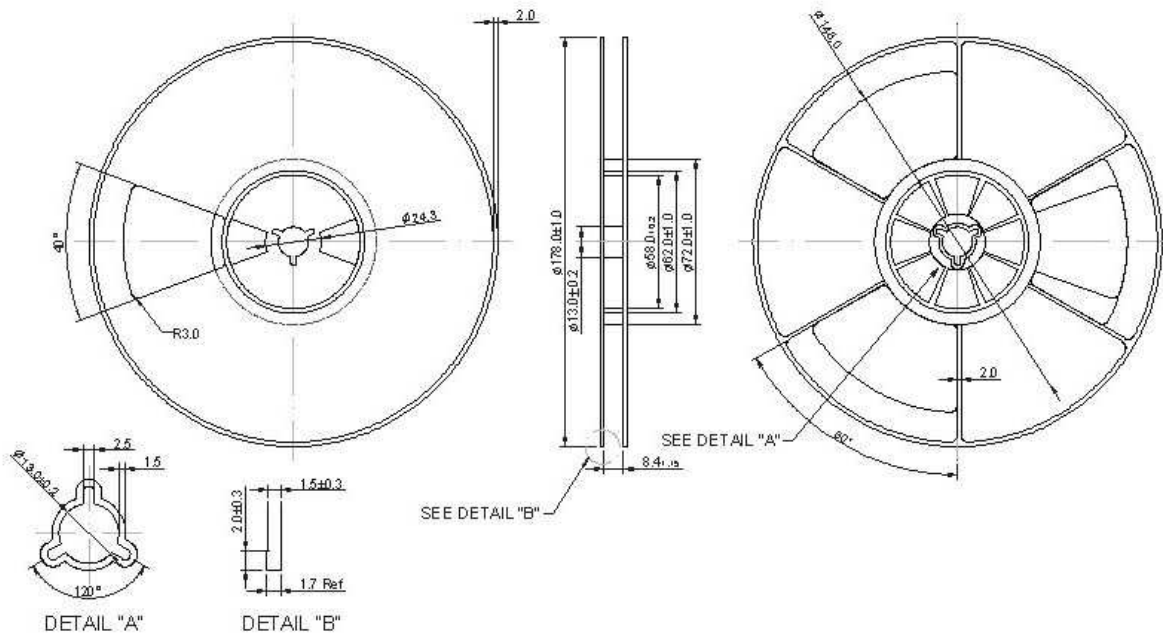

**2. TAPE DIMENSION**

