

**SAW Filter 821.0MHz**  
**Part No: MA05379**

**Model: TA0330A**  
**Rev No: 1**

**A. MAXIMUM RATING:**

1. Input Power Level: 10dBm
2. DC voltage: 3V
3. Operating Temperature: -25°C to +75°C
4. Storage Temperature: -40°C to +85°C

**B. ELECTRICAL CHARACTERISTICS:**

Item	Unit	Min.	Typ.	Max.
Center Frequency Fc	MHz	-	821	-
Insertion Loss 816 ~ 826MHz	dB	-	1.9	3.5
Ripple 816 ~ 826MHz	dB	-	0.2	2.0
VSWR 816 ~ 826MHz		-	1.3	2.0
Absolute Attenuation 861 ~ 871MHz	dB	20	37	-
Source impedance Z <sub>S</sub>	Ω	-	50	-
Load impedance Z <sub>L</sub>	Ω	-	50	-

Note: No matching network required for operation at 50Ω

**SAW Filter 821.0MHz**  
**Part No: MA05379**

**Model: TA0330A**  
**Rev No: 1**

**C. FREQUENCY CHARACTERISTICS:**

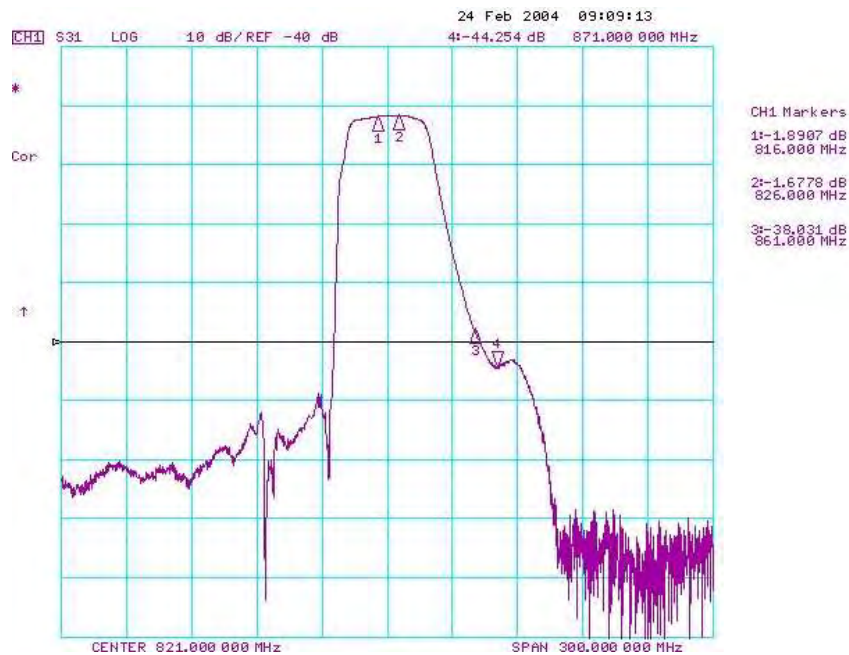
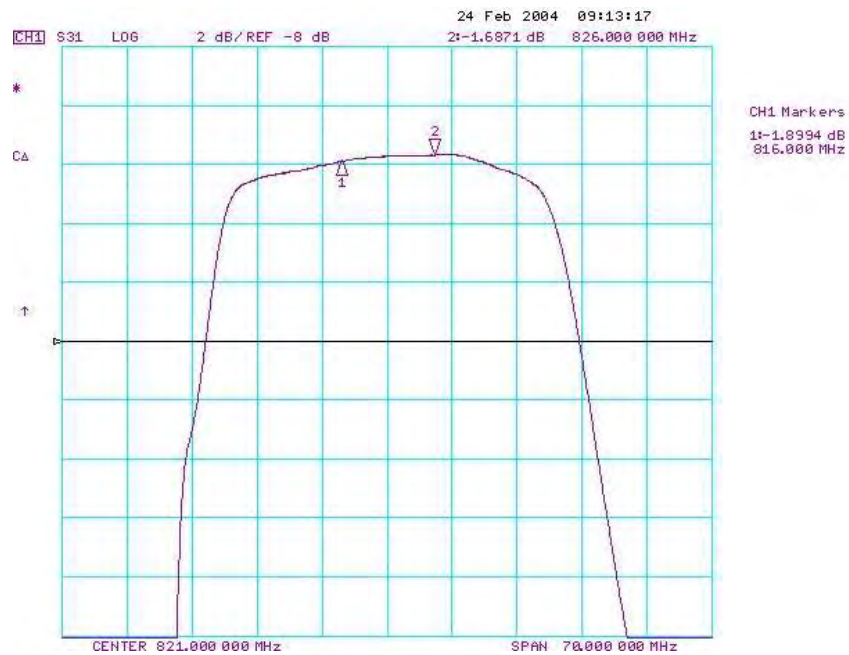

**SAW Filter 821.0MHz**  
**Part No: MA05379**

**Model: TA0330A**  
**Rev No: 1**

Reflection functions

S11

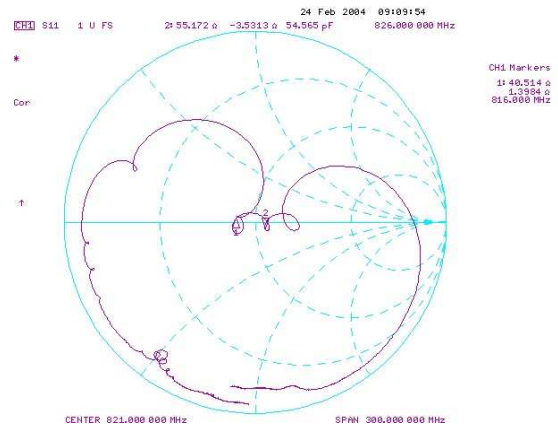
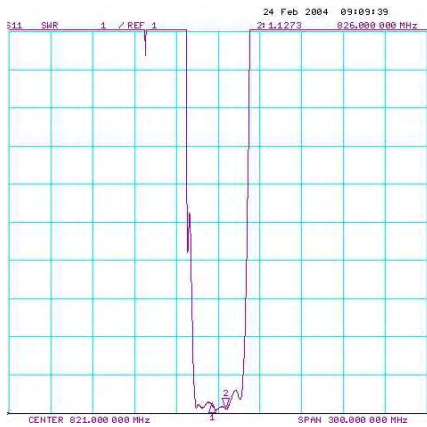

S22

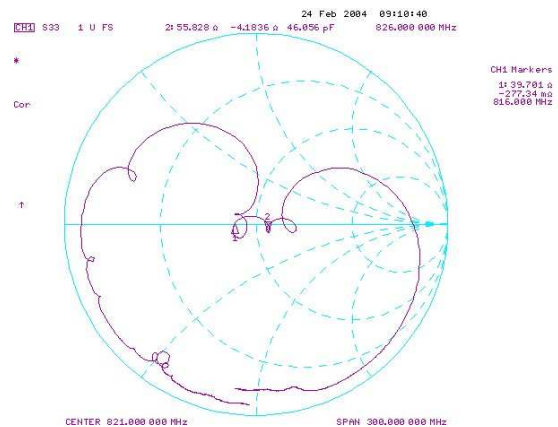
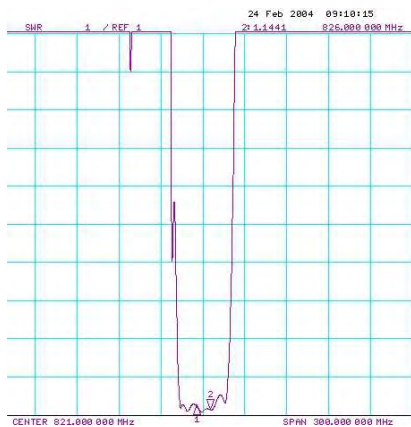

**SAW Filter 821.0MHz**  
**Part No: MA05379**

**Model: TA0330A**  
**Rev No: 1**

**D. MEASUREMENT CIRCUIT:**

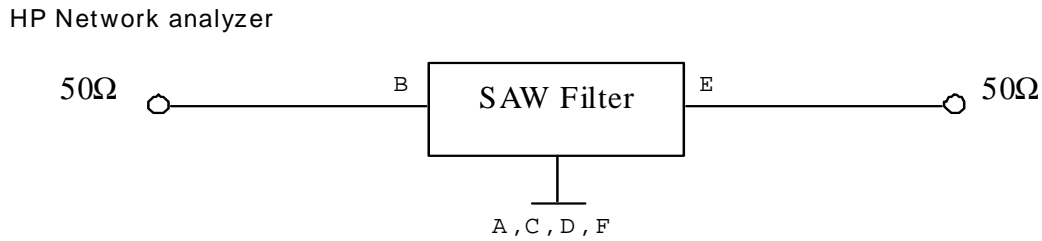

**E. OUTLINE DRAWING:**

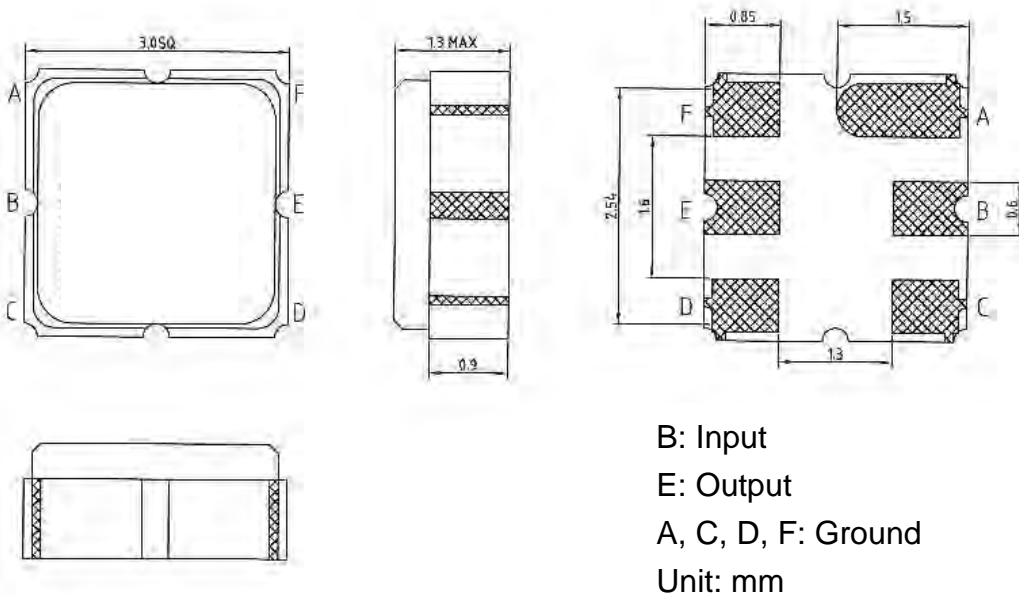

**SAW Filter 821.0MHz**  
**Part No: MA05379**

**Model: TA0330A**  
**Rev No: 1**

**F. PACKING:**

**1. REEL DIMENSION**

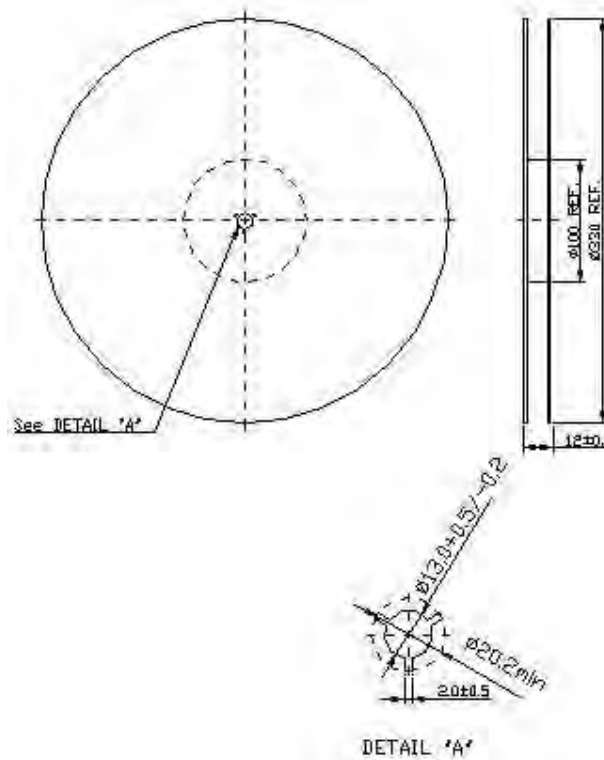

**2. TAPE DIMENSION**

