

SAW Filter 403.5MHz
Part No: MP02719

Model: TA0997A
 REV. NO.: 2

A. MAXIMUM RATING:

1. Input Power Level: 17 dBm
2. DC Voltage : 3V
3. Operating Temperature: +20°C to +50°C
4. Storage Temperature: -55°C to +85°C

B. ELECTRICAL CHARACTERISTICS:

Item	Unit	Min.	Typ.	Max.	Note
Center Frequency Fc	MHz	-	403.5	-	-
Min. Insertion loss (402~405MHz) IL	dB	-	1.8	2.5	-
Amplitude Ripple (402 ~ 405 MHz)	dB	-	0.75	1	-
Bandwidth	MHz	3	5	10	-
VSWR (402~405 MHz)		-	1.6	2.1	-
Attenuation (Reference level from 0 dB)					
0.3 ~ 359MHz	dB	50	55	-	-
359 ~ 391MHz	dB	40	56	-	-
391 ~ 397MHz	dB	15	38	-	-
411 ~ 415MHz	dB	10	31	-	-
415 ~ 423MHz	dB	20	41	-	-
423 ~ 448MHz	dB	35	56	-	-
448 ~ 500MHz	dB	52	60	-	-
Temperature Coefficient of Frequency	ppm/°C	-	-36	-	-

SAW Filter 403.5MHz
Part No: MP02719

Model: TA0997A
 REV. NO.: 2

C. OUTLINE DRAWING:

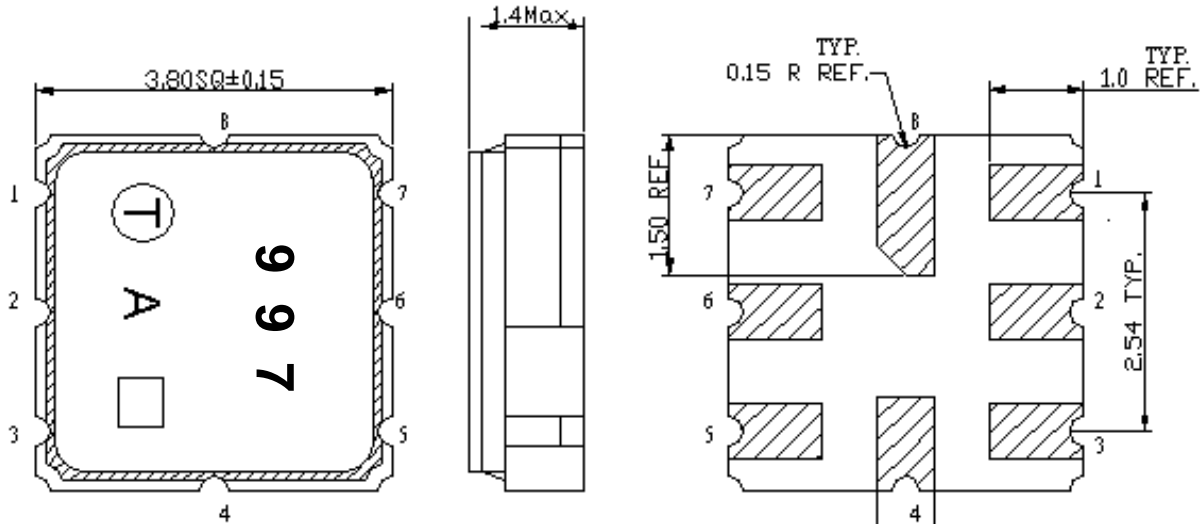

- 1 : Output
- 2 : Output
- 5: Input
- 6: Input RF Return
- 3,4,7,8: Ground
- Unit: mm

D. MEASUREMENT CIRCUIT:

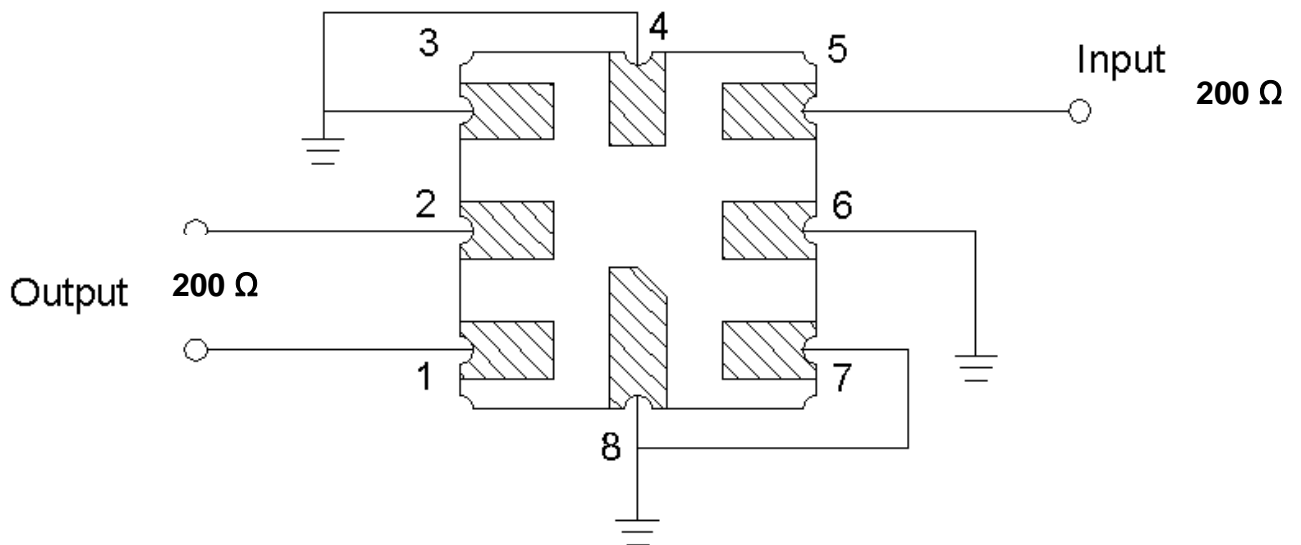

SAW Filter 403.5MHz
Part No: MP02719

Model: TA0997A
REV. NO.: 2

E. PCB FOOTPRINT:

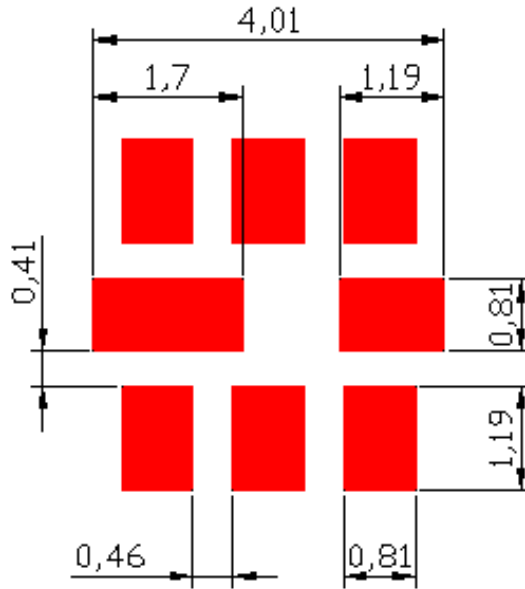

SAW Filter 403.5MHz
Part No: MP02719

Model: TA0997A
REV. NO.: 2

F. FREQUENCY CHARACTERISTICS:

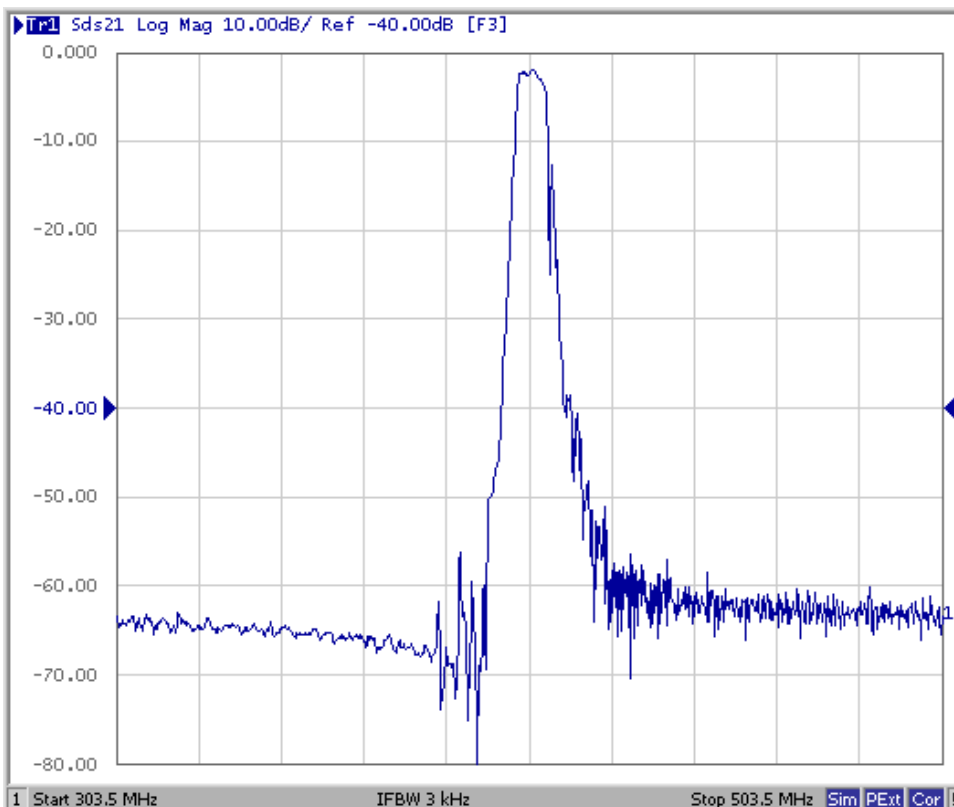
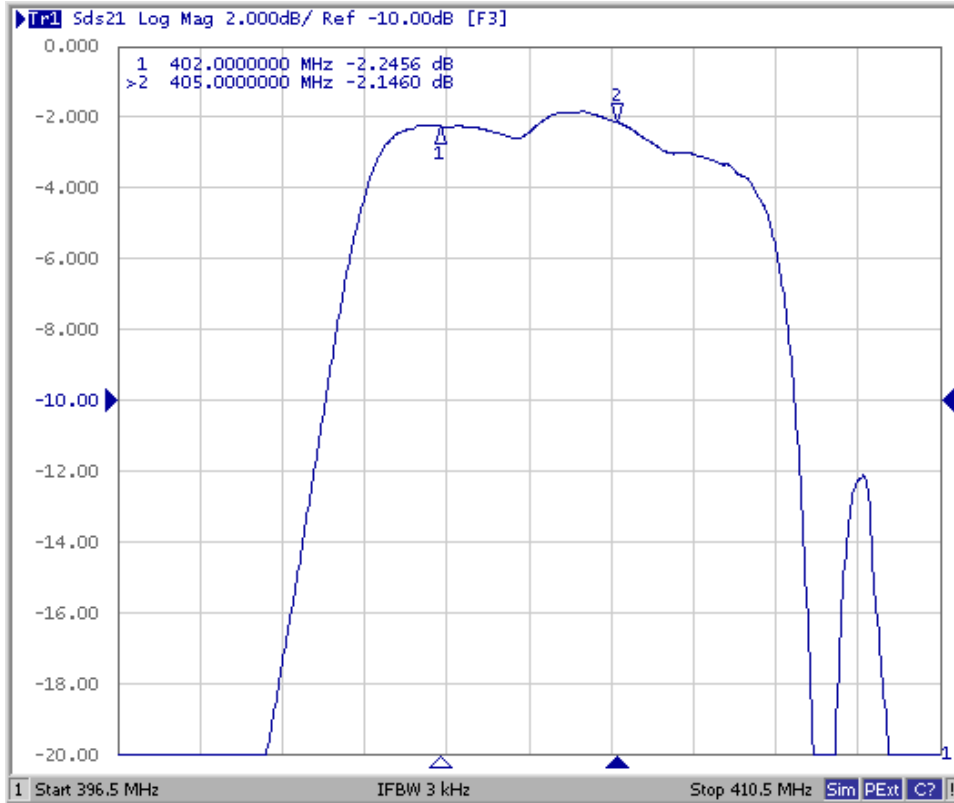

SAW Filter 403.5MHz
Part No: MP02719

Model: TA0997A
REV. NO.: 2

Reflection Functions:

S11

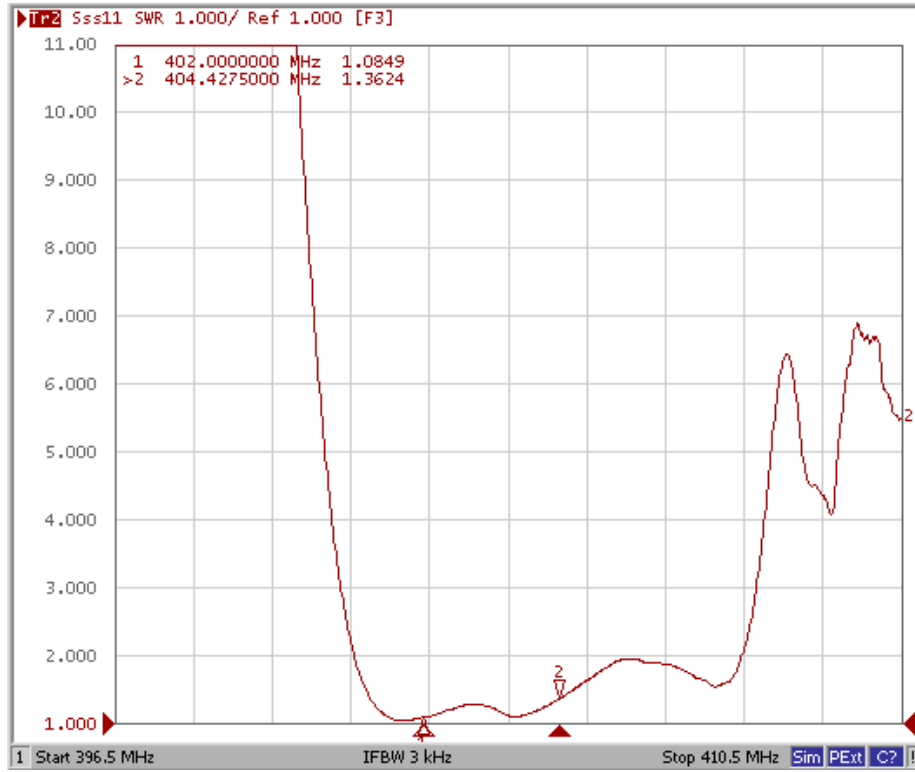

S22

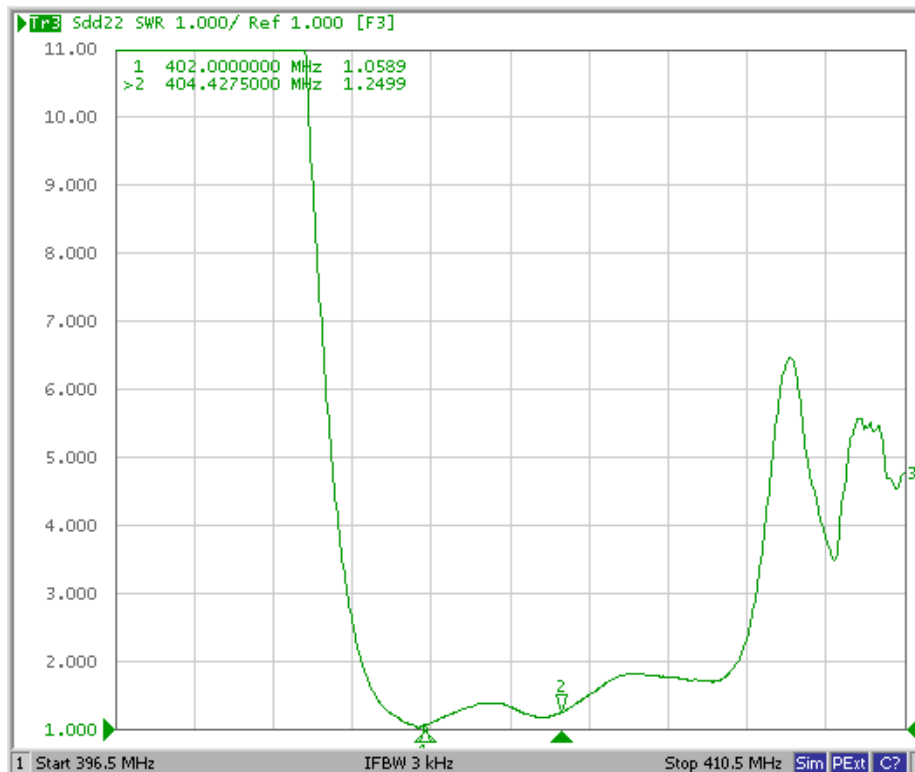

SAW Filter 403.5MHz
Part No: MP02719

Model: TA0997A
REV. NO.: 2

H. RECOMMENDED REFLOW PROFILE:

