

SAW Filter 830.05MHz
Part No: MP03055

Model: TA0511A
Rev No: 1

A. MAXIMUM RATING:

1. Input Power Level: 13dBm
2. DC voltage: 5V
3. Operating Temperature: -20°C to +70°C
4. Storage Temperature: -30°C to +85°C

B. ELECTRICAL CHARACTERISTICS:

Item	Unit	Min.	Typ.	Max.
Center frequency Fc	MHz	-	830.05	-
1.5 -dB Bandwidth	MHz	-	Fo±4.5	-
Operational Bandwidth	MHz	825.5	-	834.6
Insertion Loss at Fc	dB	-	2.7	4.5
Amplitude Variation (825.5 ~ 834.6MHz)	dB	-	0.5	1.5
Attenuation (Reference level from 0dB)				
0 ~ 808MHz	dB	35	58	-
808 ~ 816MHz	dB	10	32	-
842 ~ 850MHz	dB	10	24	-
850 ~ 858MHz	dB	30	40	-
858 ~ 2000MHz	dB	34	38	-
Input/Output VSWR (825.5 ~ 834.6MHz)		-	1.7	2.5
Source impedance Z _S	Ω	-	50	-
Load impedance Z _L	Ω	-	50	-

C. MEASUREMENT CIRCUIT:

HP Network analyzer

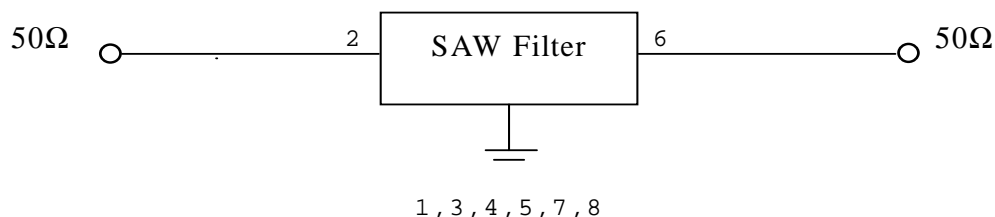

SAW Filter 830.05MHz
Part No: MP03055

Model: TA0511A
Rev No: 1

D. OUTLINE DRAWING:

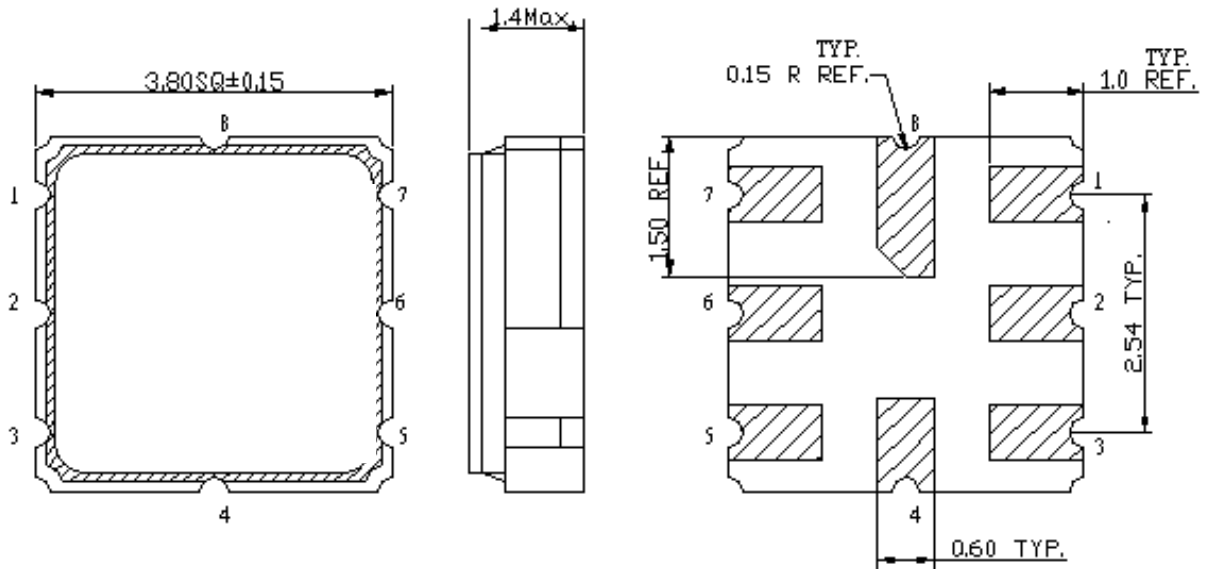

2: Input
 6: Output
 1, 3, 4, 5, 7, 8: Ground
 Unit: mm

E. PCB FOOTPRINT:

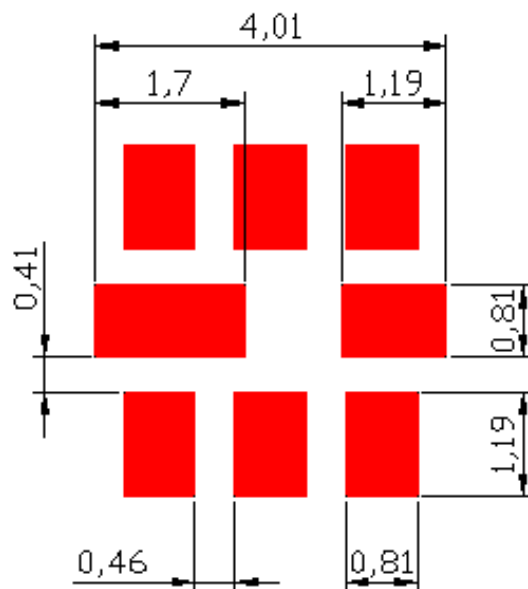

SAW Filter 830.05MHz
Part No: MP03055

Model: TA0511A
Rev No: 1

F. FREQUENCY CHARACTERISTICS:

Transfer function

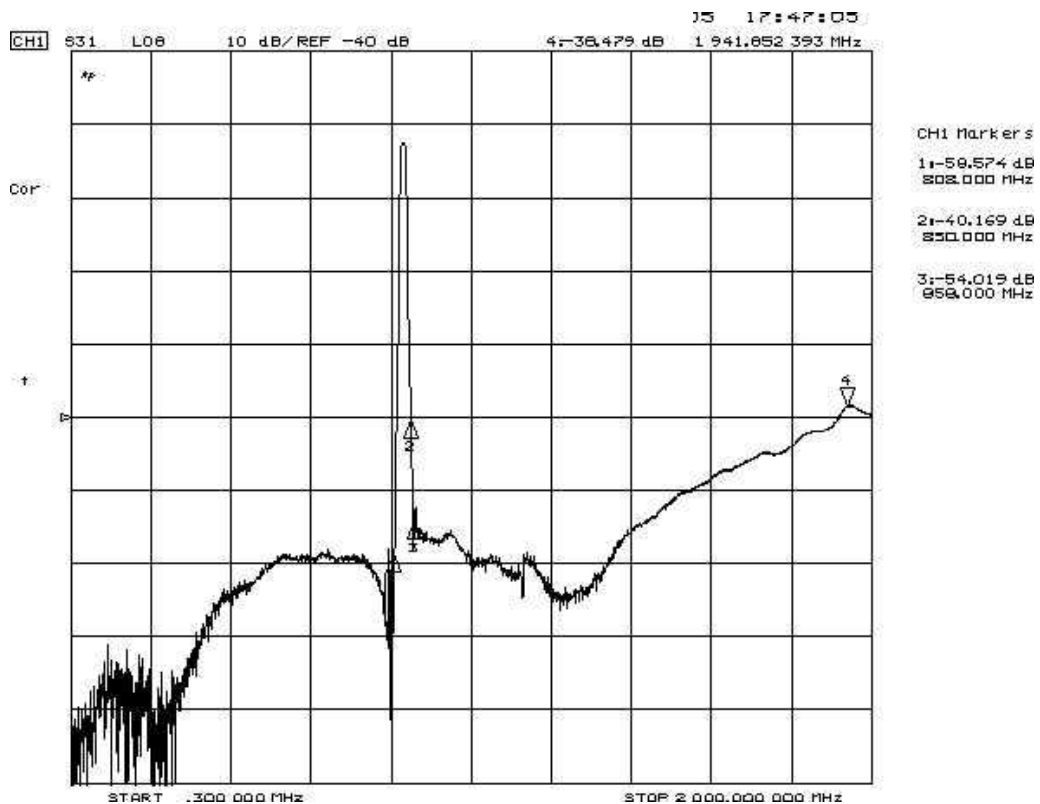
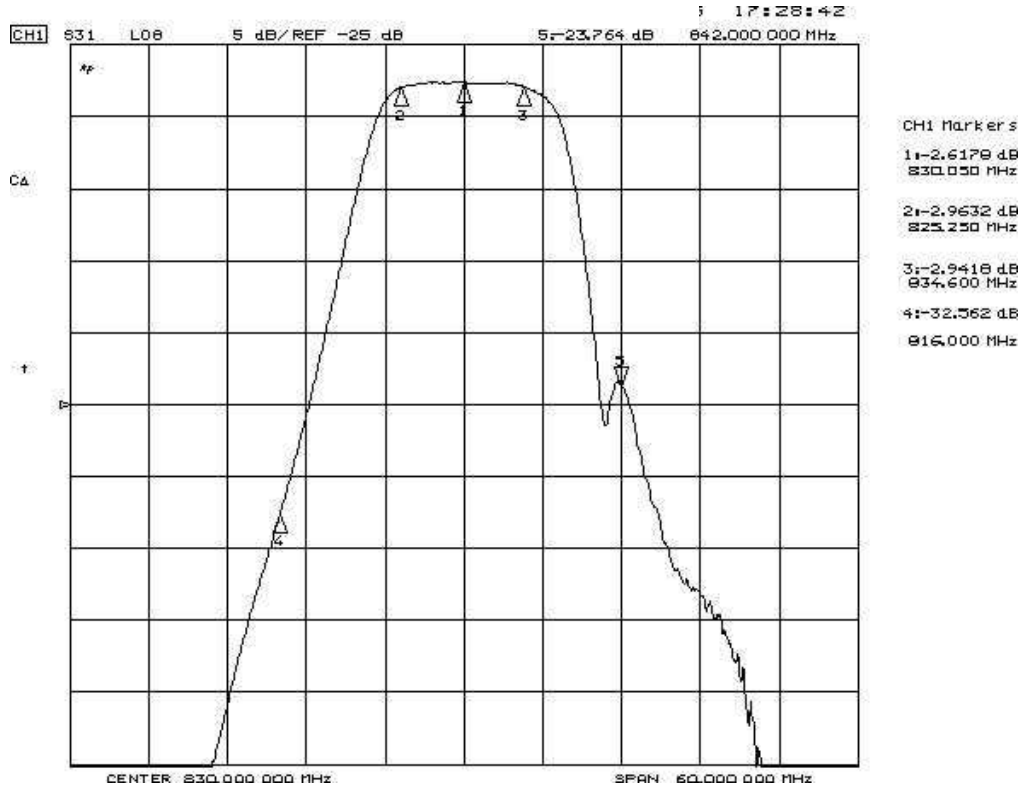

SAW Filter 830.05MHz
Part No: MP03055

Model: TA0511A
Rev No: 1

Reflections Functions

S11

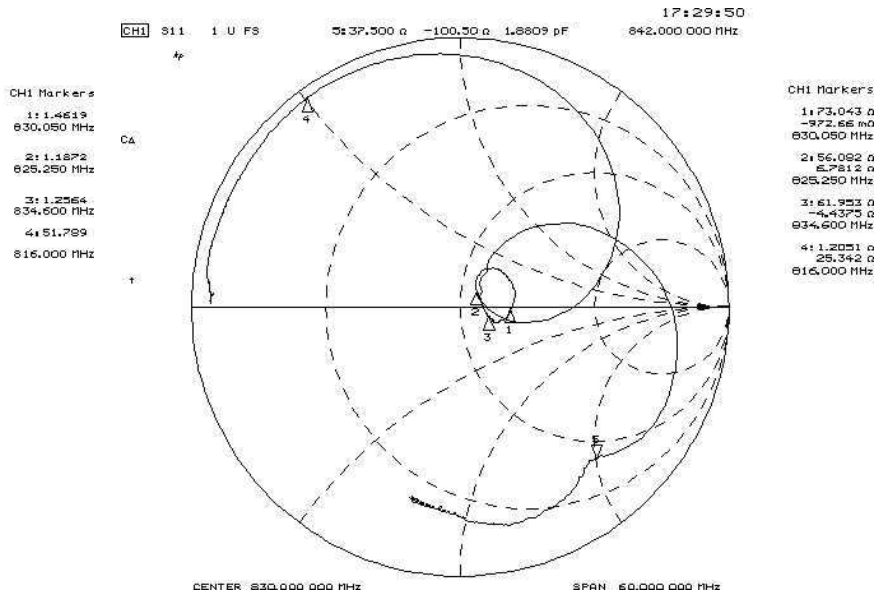
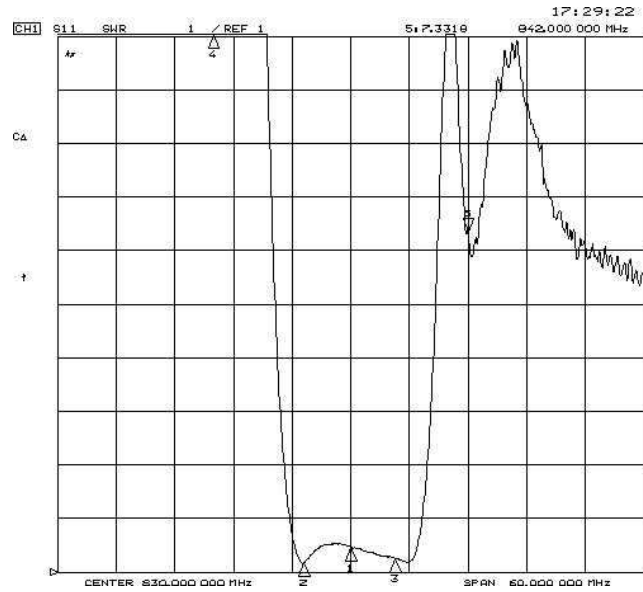

S22

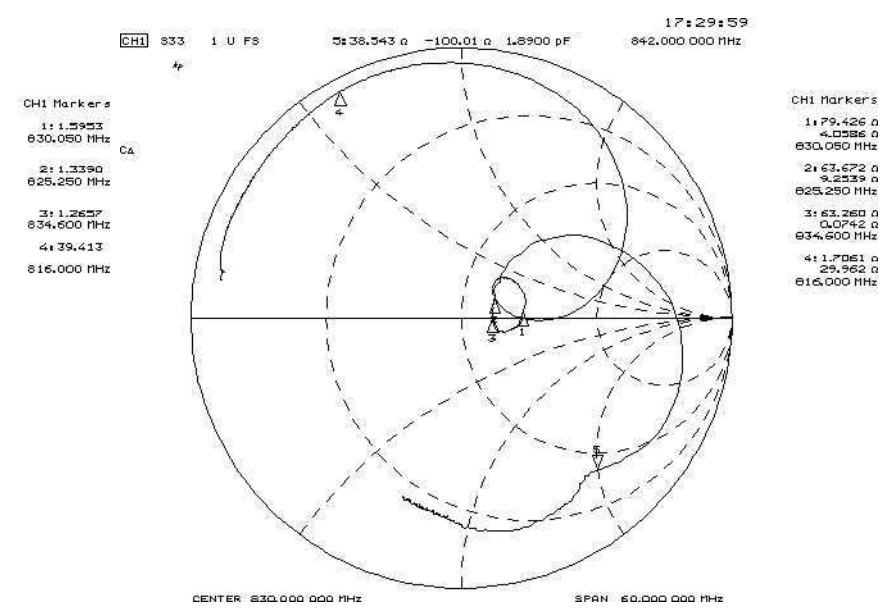
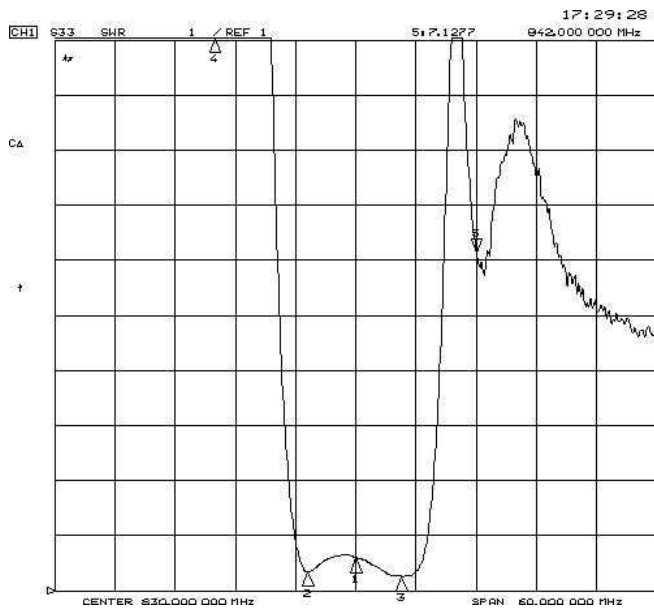

SAW Filter 830.05MHz
Part No: MP03055

Model: TA0511A
Rev No: 1

G. PACKING:

1. REEL DIMENSION

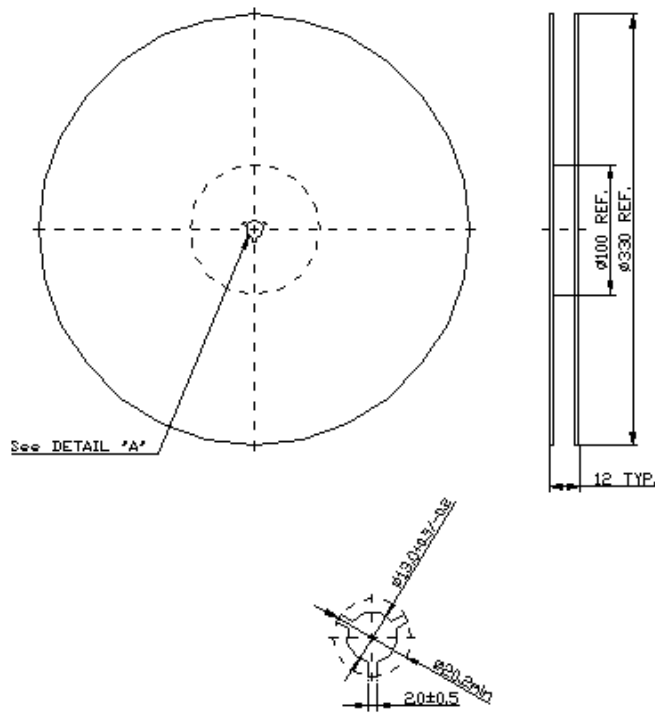

2. TAPE DIMENSION

