

**SAW Filter 402.0MHz**  
**Part No: MP03718**

**Model: TA0980A**  
**Rev No: 4**

**A. MAXIMUM RATING:**

Electrostatic Sensitive Device (ESD)

1. Input Power Level: 15dBm
2. DC voltage: 3V
3. Operating Temperature: -40°C to +85°C
4. Storage Temperature: -40°C to +85°C

**B. ELECTRICAL CHARACTERISTICS:**

| Item                                   | Unit | Min. | Typ. | Max. |
|----------------------------------------|------|------|------|------|
| Center frequency Fc                    | MHz  | -    | 402  | -    |
| Insertion Loss 400 ~ 404MHz IL         | dB   | -    | 2.0  | 4.5  |
| Amplitude ripple 400 ~ 404MHz          | dB   | -    | 0.5  | 2.0  |
| Attenuation:(Reference level from 0dB) |      |      |      |      |
| 202 ~ 372MHz                           | dB   | 45   | 65   | -    |
| 372 ~ 382MHz                           | dB   | 40   | 55   | -    |
| 382 ~ 392MHz                           | dB   | 30   | 42   | -    |
| 412 ~ 422MHz                           | dB   | 30   | 34   | -    |
| 422 ~ 432MHz                           | dB   | 40   | 55   | -    |
| 432 ~ 602MHz                           | dB   | 45   | 55   | -    |
| 800 ~ 1300MHz                          | dB   | 40   | 43   | -    |
| Source impedance Z <sub>S</sub>        | Ω    | -    | 50   | -    |
| Load impedance Z <sub>L</sub>          | Ω    | -    | 50   | -    |

Note: No matching network required for operation at 50Ω

**C. MEASUREMENT CIRCUIT:**

HP Network analyzer

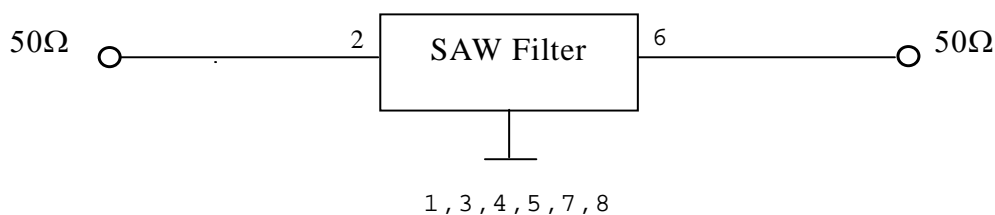

**SAW Filter 402.0MHz**  
**Part No: MP03718**

**Model: TA0980A**  
**Rev No: 4**

**D. FREQUENCY CHARACTERISTICS:**

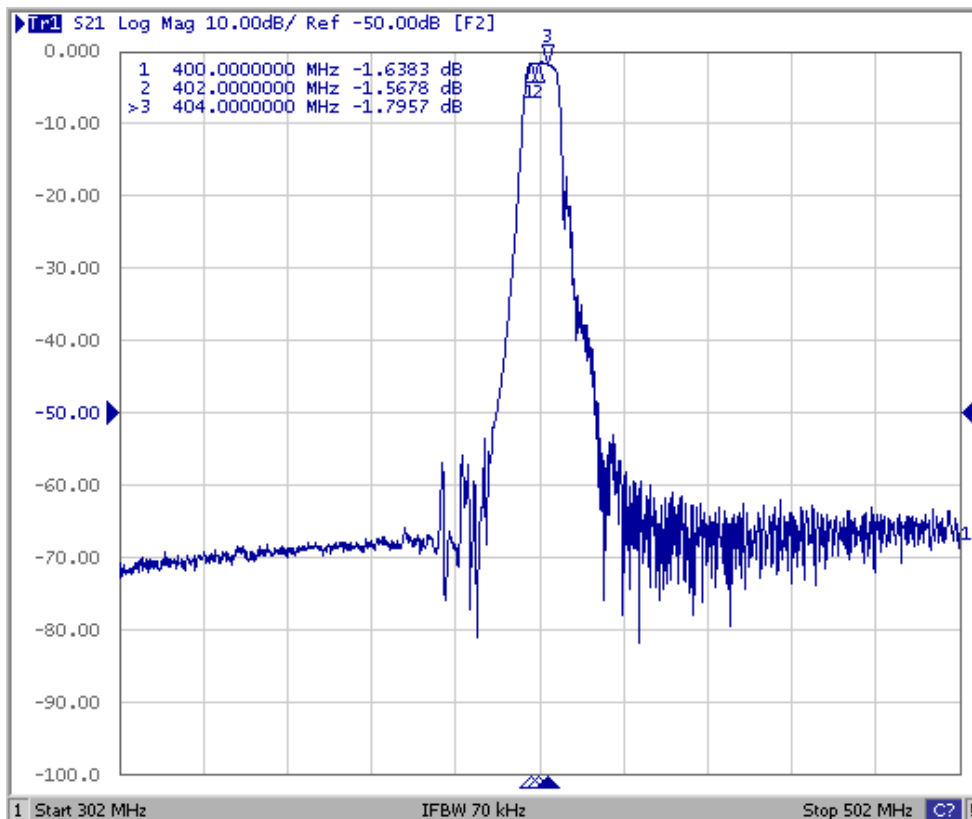
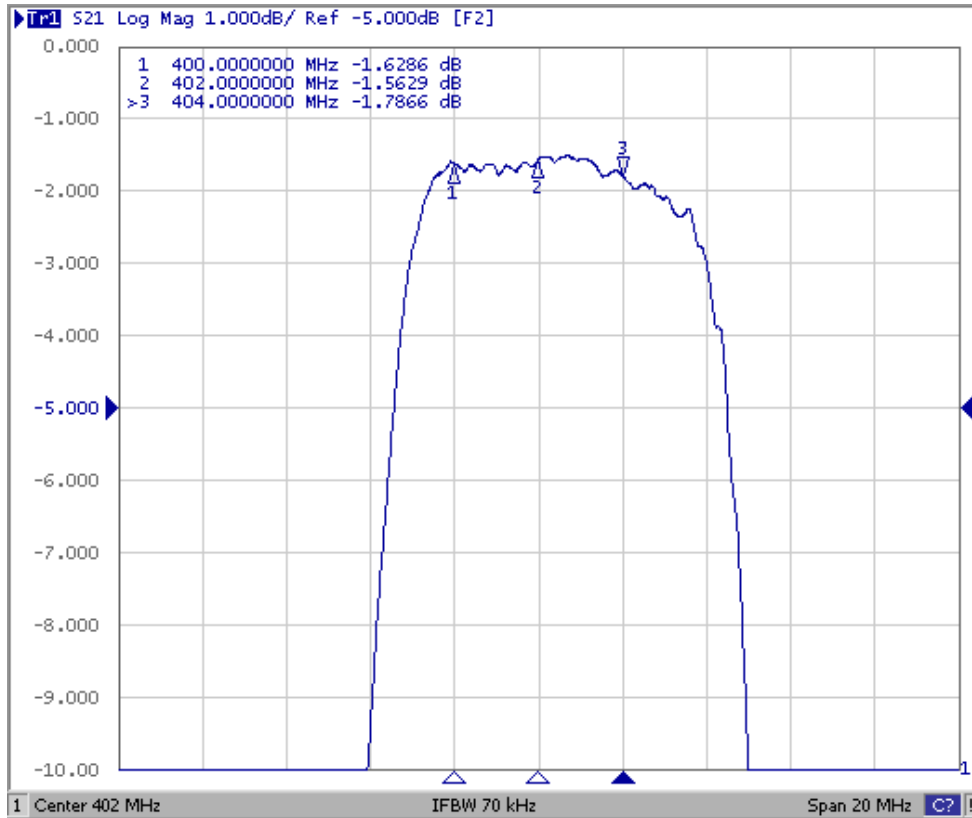

**SAW Filter 402.0MHz**  
**Part No: MP03718**

**Model: TA0980A**  
**Rev No: 4**

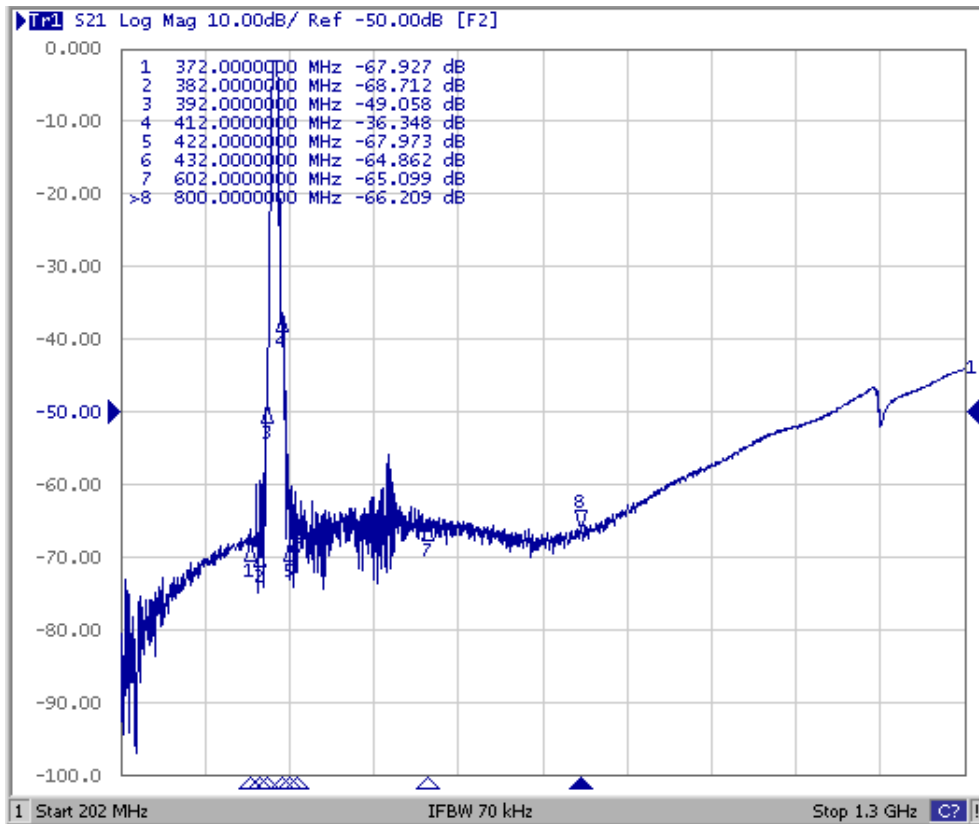

**SAW Filter 402.0MHz**  
**Part No: MP03718**

**Model: TA0980A**  
**Rev No: 4**

**E. OUTLINE DRAWING:**

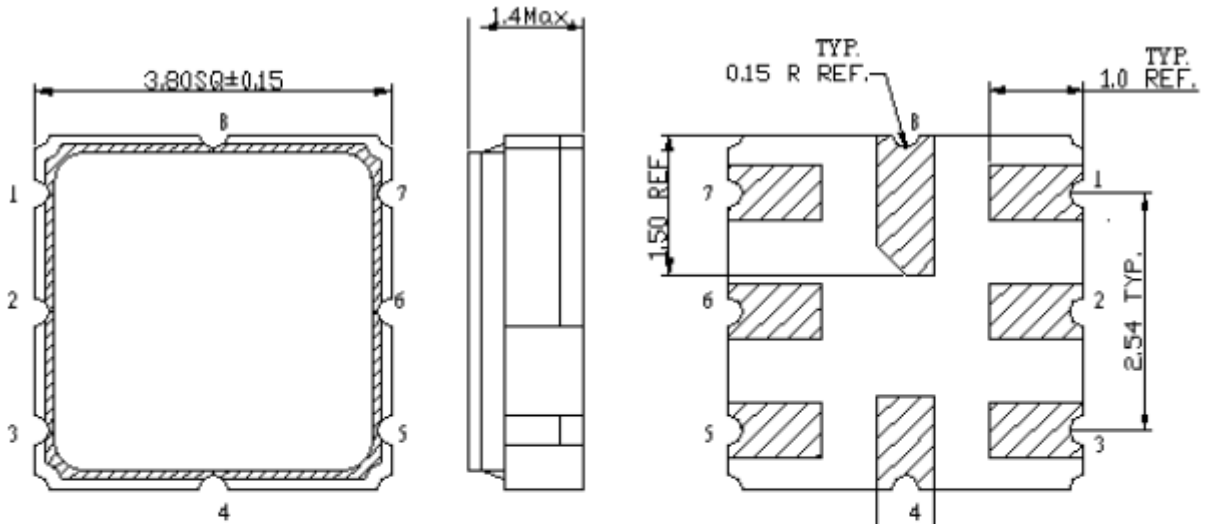

2 : Input  
 6 : Output  
 1,3,4,5,7,8: Ground

**F. PCB FOOTPRINT:**

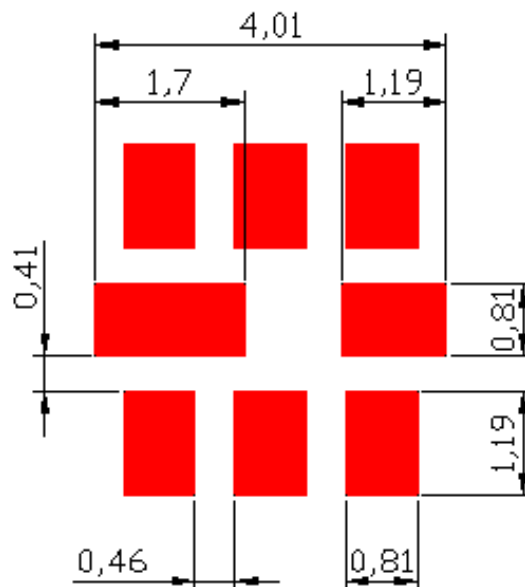

**SAW Filter 402.0MHz**  
**Part No: MP03718**

**Model: TA0980A**  
**Rev No: 4**

**G. PACKING:**

1. Reel Dimension

(Reel Count : 7"=1000 ; 13"=3000 or per the request of customer order)

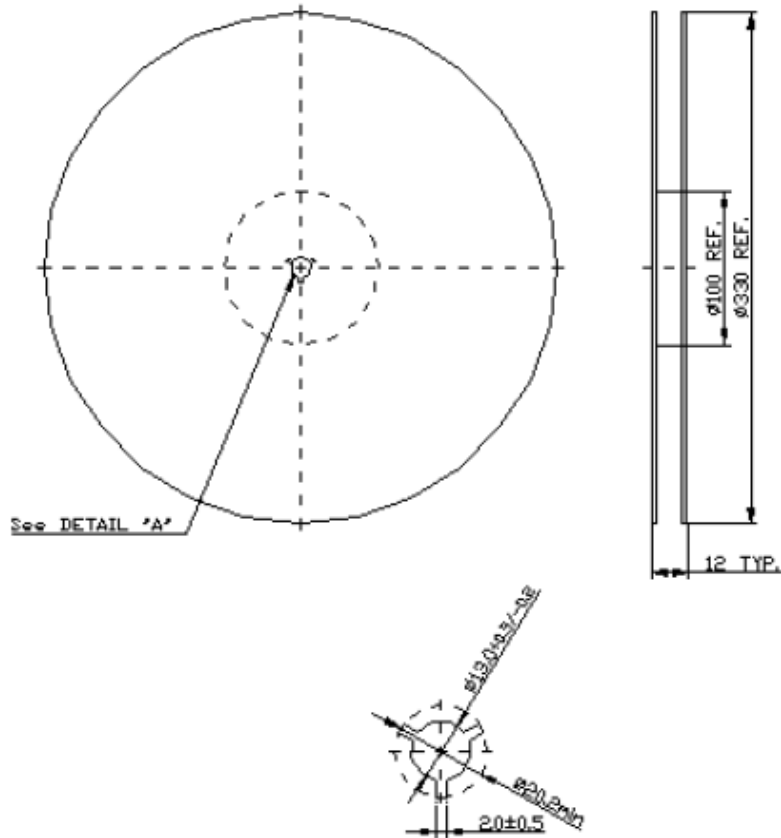

2. Tape Dimension

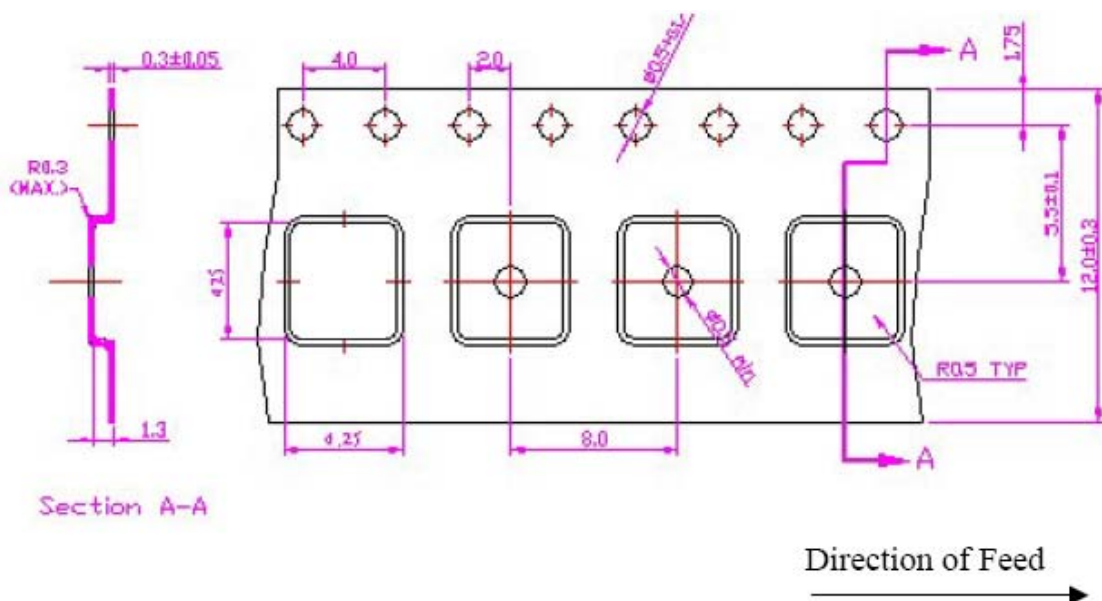

**SAW Filter 402.0MHz**  
**Part No: MP03718**

**Model: TA0980A**  
**Rev No: 4**

**H. RECOMMENDED REFLOW PROFILE:**

