

SAW Filter 1090.0MHz
Part No: MP07576

Model: TA1992A
Rev. No: 1

A. MAXIMUM RATING:

Electrostatic Sensitive Device (ESD)

1. Input Power Level: 15dBm
2. DC Voltage: 3V
3. Operating Temperature: -55°C to +85°C
4. Storage Temperature: -55°C to +85°C

B. ELECTRICAL CHARACTERISTICS:

1. Terminating source impedance (single): $Z_S = 50\Omega$
2. Terminating load impedance (single): $Z_L = 50\Omega$

Item	Unit	Min.	Typ.	Max
Center frequency F_c	MHz	-	1090	-
Insertion Loss (1085 ~ 1095MHz) IL	dB	-	3.0	4.0
Amplitude ripple (1085 ~ 1095MHz)	dB	-	0.8	1.2
Group Delay Variation (1085 ~ 1095MHz)	ns	-	20	37
Attenuation (Reference level from 0dB)				
500 ~ 1006MHz	dB	54	60	-
1006 ~ 1040MHz	dB	50	55	-
1040 ~ 1050MHz	dB	48	53	-
1140 ~ 1160MHz	dB	50	55	-
1160 ~ 1300MHz	dB	54	60	-
1300 ~ 1600MHz	dB	48	53	-
Temperature coefficient of frequency	ppm/oC	-	-36	-

C. TEST CIRCUIT: (NA simulation)

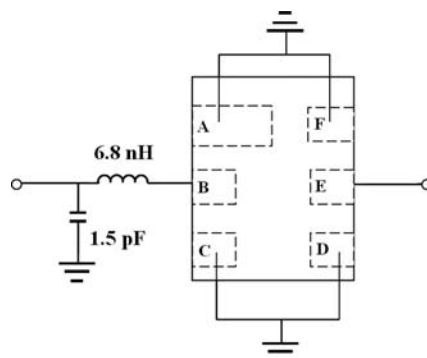

SAW Filter 1090.0MHz
Part No: MP07576

Model: TA1992A
Rev. No: 1

D. FREQUENCY CHARACTERISTICS:

1. S21 response: Center 1090MHz, Span 400MHz

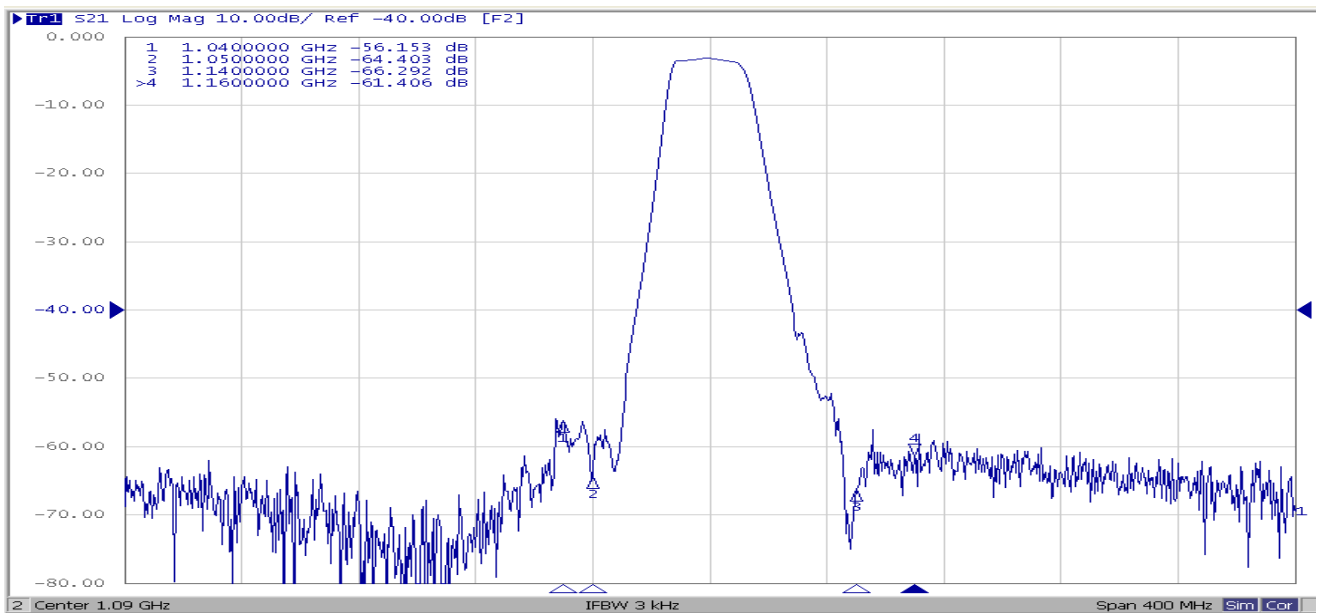

2. S21 responds: Span 40MHz

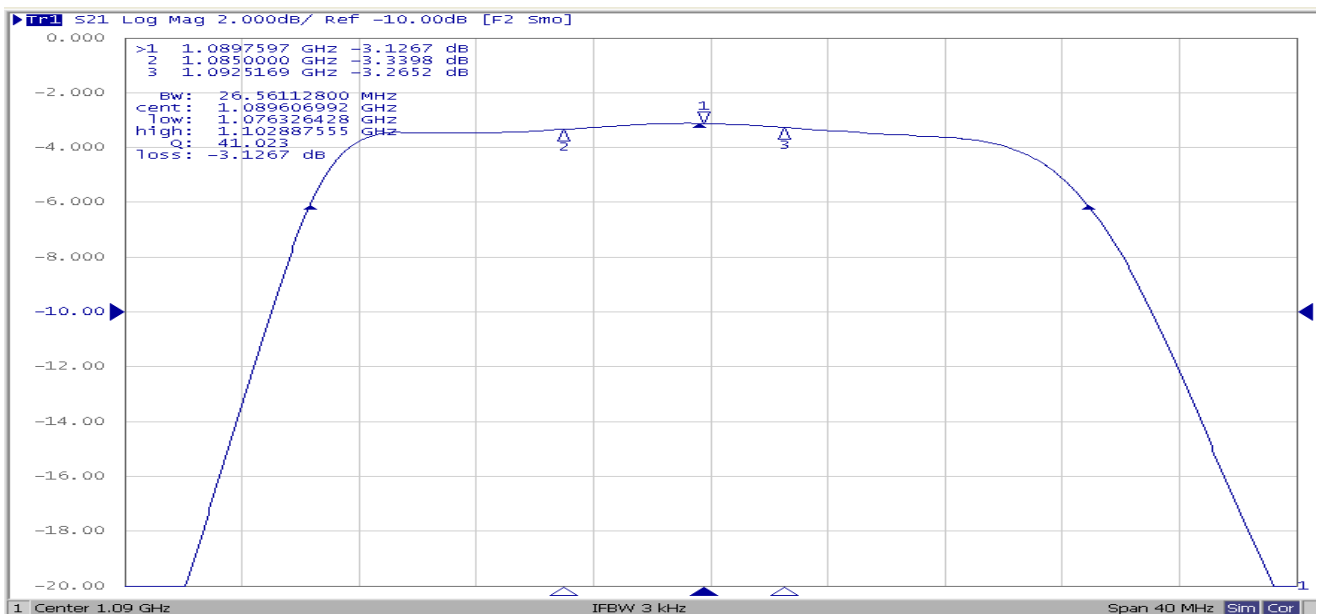

SAW Filter 1090.0MHz
Part No: MP07576

Model: TA1992A
Rev. No: 1

3. S21 response: 10MHz ~ 2000MHz

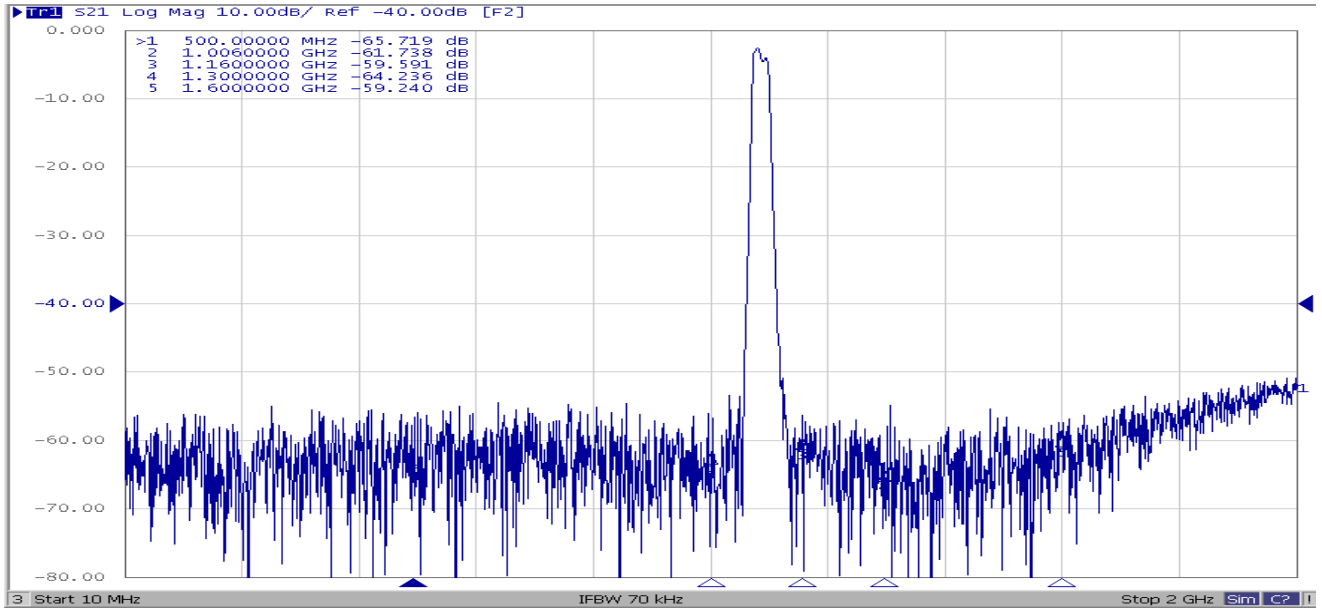

4. Group Delay Variation

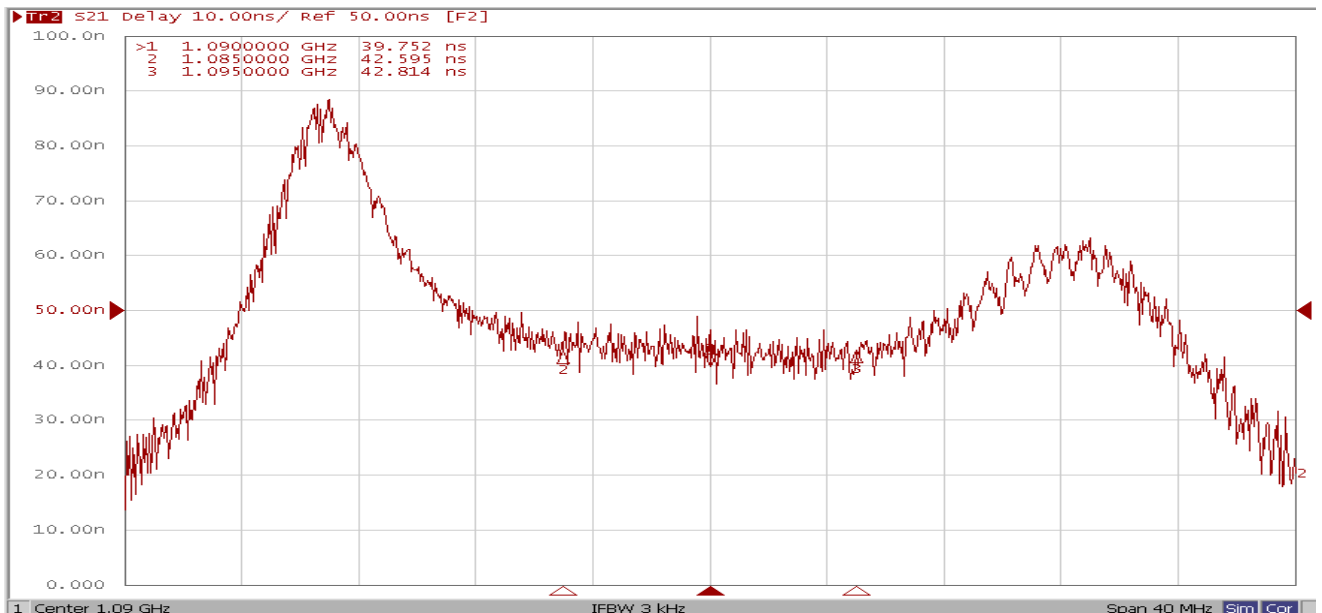

SAW Filter 1090.0MHz
Part No: MP07576

Model: TA1992A
Rev. No: 1

Reflection Functions

S11 VSWR: Center 1090MHz, Span 40MHz

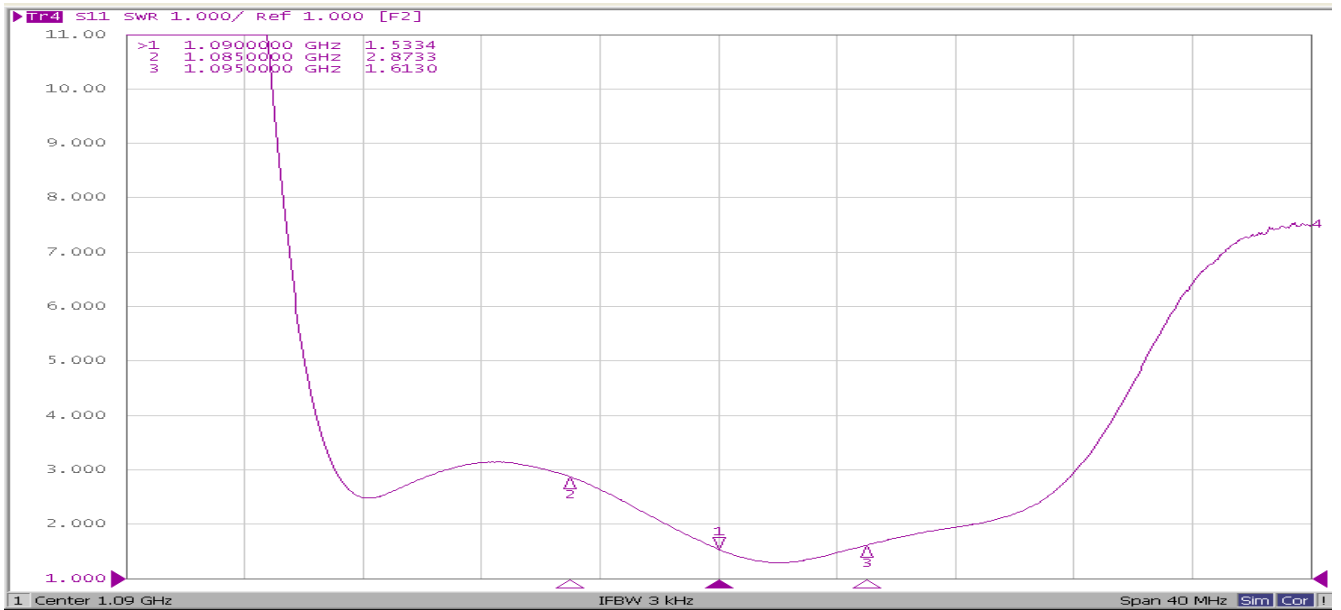

S11 VSWR: Center 1090MHz, Span 40MHz

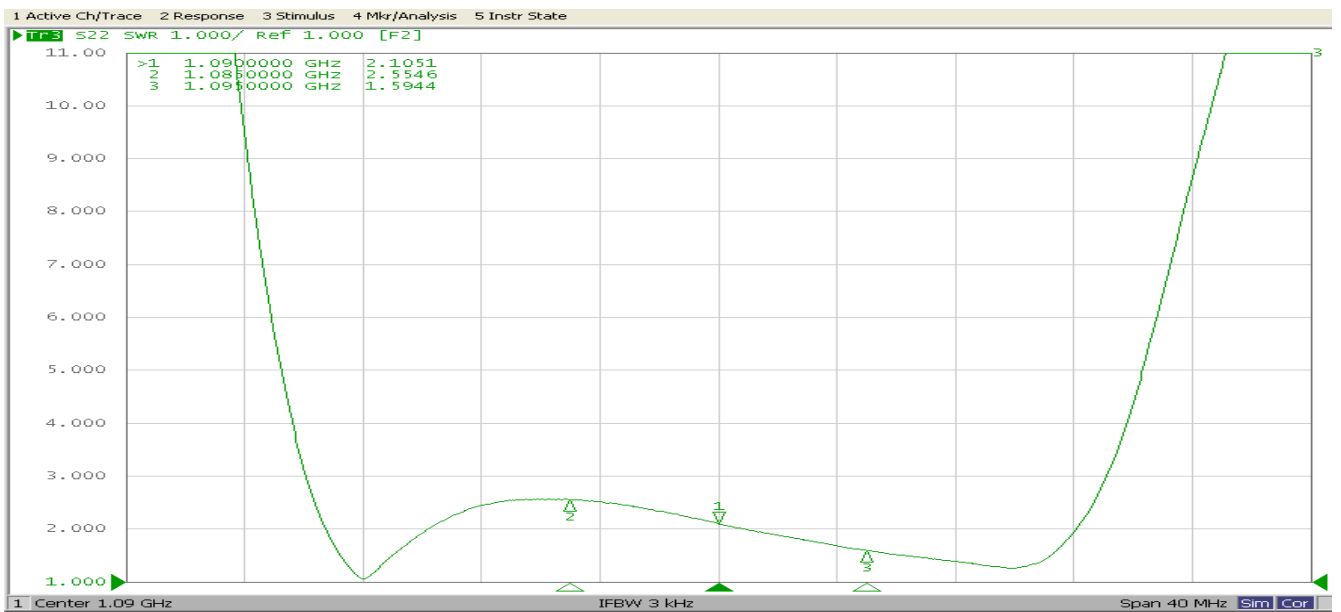

SAW Filter 1090.0MHz
Part No: MP07576

Model: TA1992A
Rev. No: 1

E. OUTLINE DRAWING:

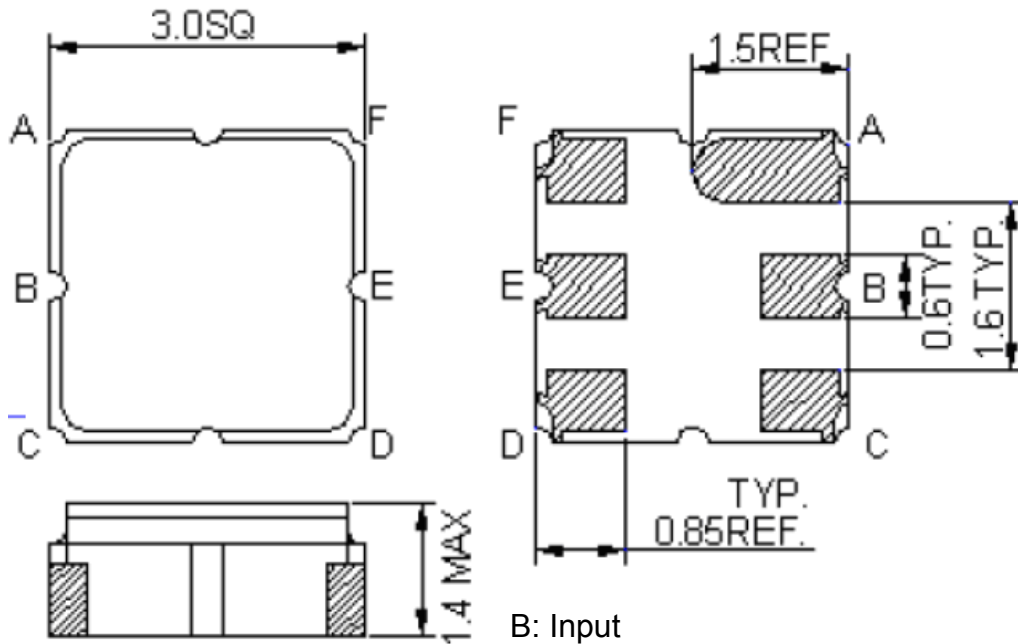

B: Input
 E: Output
 A, C, D, F: Ground
 Unit: mm

F. PCB FOOTPRINT:

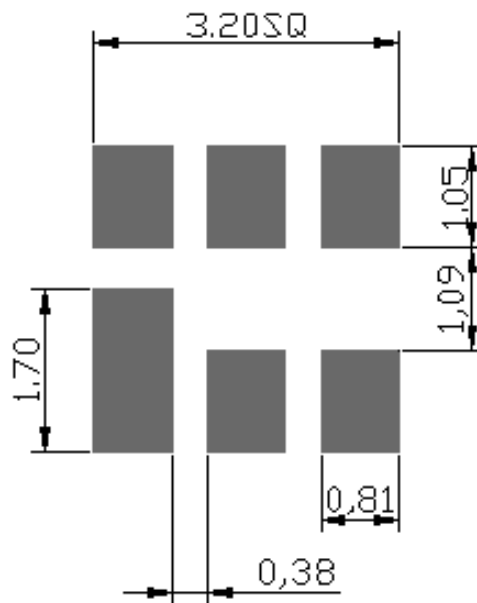

SAW Filter 1090.0MHz
Part No: MP07576

Model: TA1992A
Rev. No: 1

G. PACKING:

1. Reel Dimension (Please refer to FR-75D10 for packing quantity)

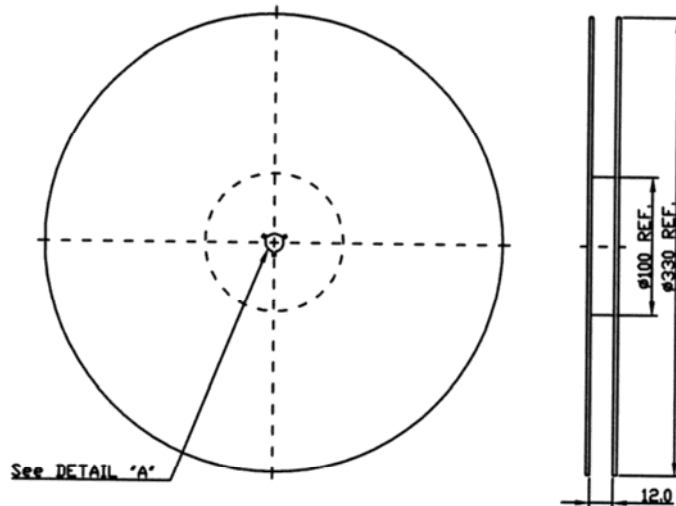

2. Tape Dimension

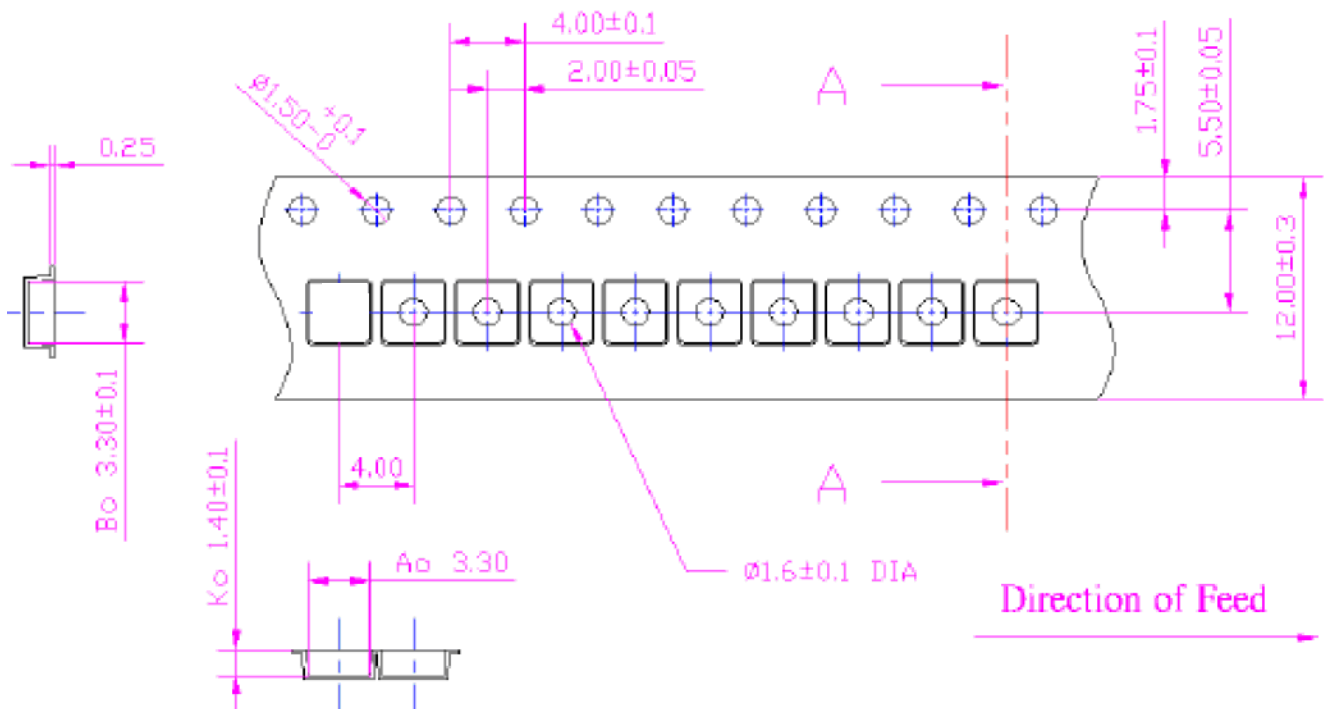

SAW Filter 1090.0MHz
Part No: MP07576

Model: TA1992A
Rev. No: 1

H. RECOMMENDED REFLOW PROFILE:

1. Preheating shall be fixed at 150 ~ 180°C for 60 ~ 90 seconds.
2. Ascending time to preheating temperature 150°C shall be 30 seconds min.
3. Heating shall be fixed at 220°C for 50 ~ 80 seconds and at 260°C +0/-5°C peak (20 ~ 40 sec).
4. Time: 2 times.

