

SAW Filter 952.50MHz
Part No: MP08738

Model No: TA1961A
Rev No: 1

A. MAXIMUM RATING:

Electrostatic Sensitive Device (ESD)

1. Input Power Level: 10dBm
2. DC Voltage: 3V
3. Operating Temperature: -40°C to +85°C
4. Storage Temperature: -40°C to +85°C

B. ELECTRICAL CHARACTERISTICS:

1. Terminating source impedance (single): $Z_S = 50\Omega$
2. Terminating load impedance (single): $Z_L = 50\Omega$

Item	Unit	Min	Typ.	Max
Center Frequency F_c	MHz	-	952.5	-
Insertion Loss (945 ~ 960MHz) IL	dB	-	2.1	3.0
Amplitude Ripple	dB	-	0.8	1.8
VSWR (945 ~ 960MHz)	dB	-	1.5	2.0
Group Delay at F_c		-	31	45
Group Delay Ripple (945 ~ 960MHz)	dB	-	20	60
Attenuation (Reference level from 0dB)				
355 ~ 920MHz	dB	33	41	-
985 ~ 1555MHz	dB	35	43	-
Temperature Coefficient	ppm/k	-	-36	-

C. TEST CIRCUIT:

HP Network analyzer

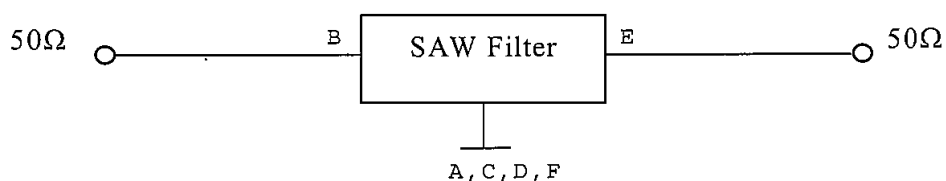

SAW Filter 952.50MHz
Part No: MP08738

Model No: TA1961A
Rev No: 1

D. FREQUENCY CHARACTERISTICS:

1. S21 response: start 355MHz, stop 1555MHz

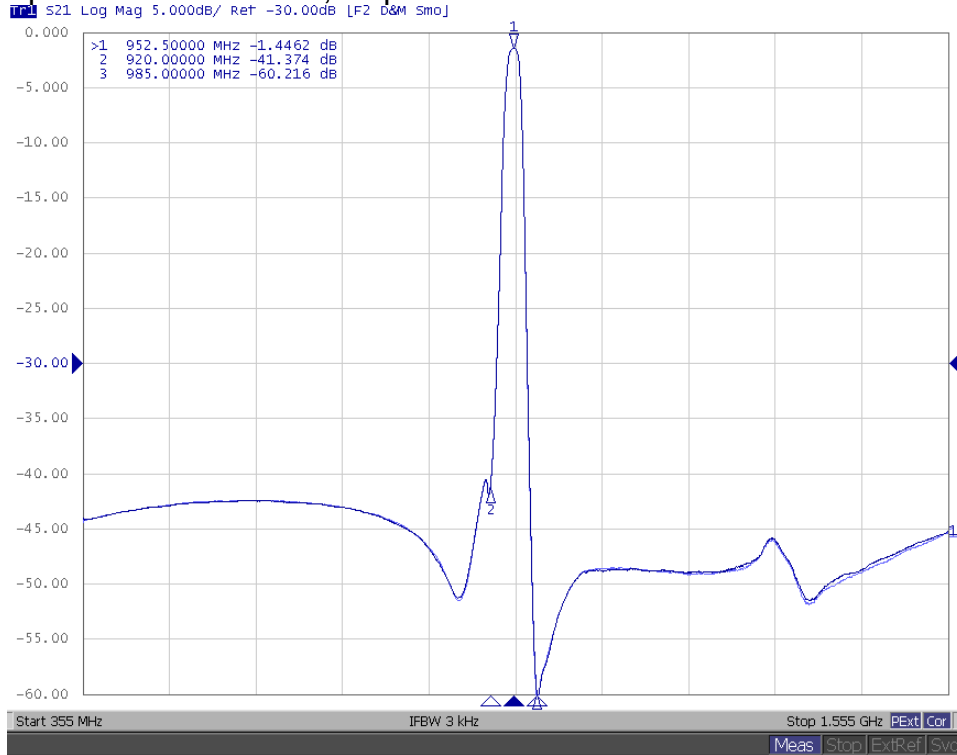

2. S21 response: center 953MHz, span 50MHz

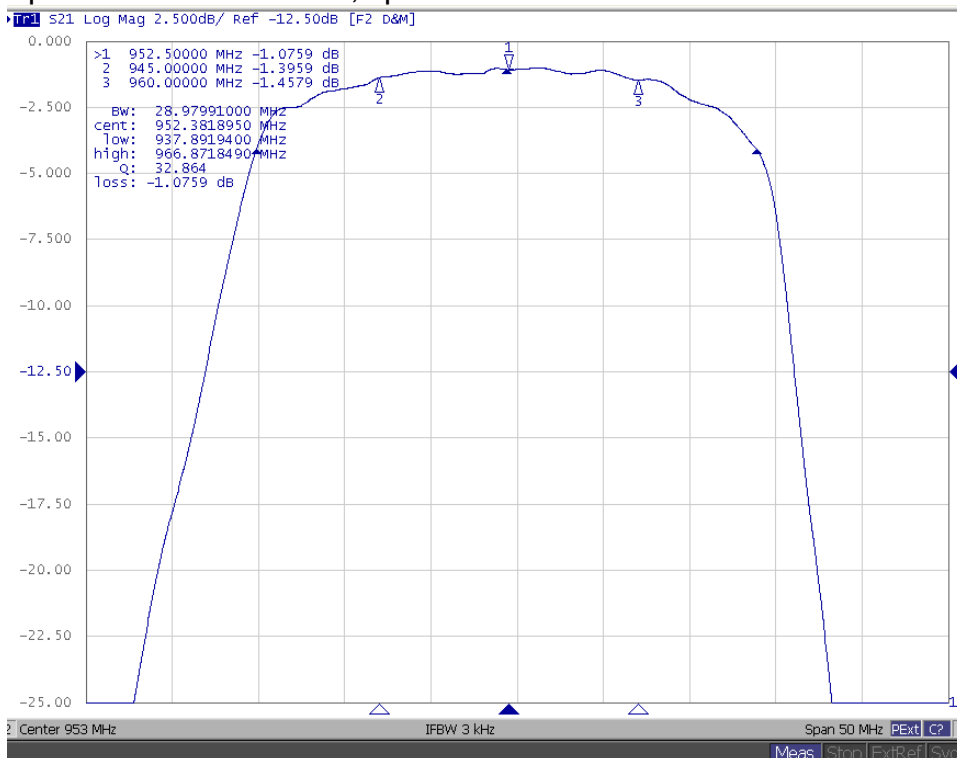

SAW Filter 952.50MHz
Part No: MP08738

Model No: TA1961A
Rev No: 1

3. S21 Amplitude Ripple: Start 945MHz, Stop 960MHz

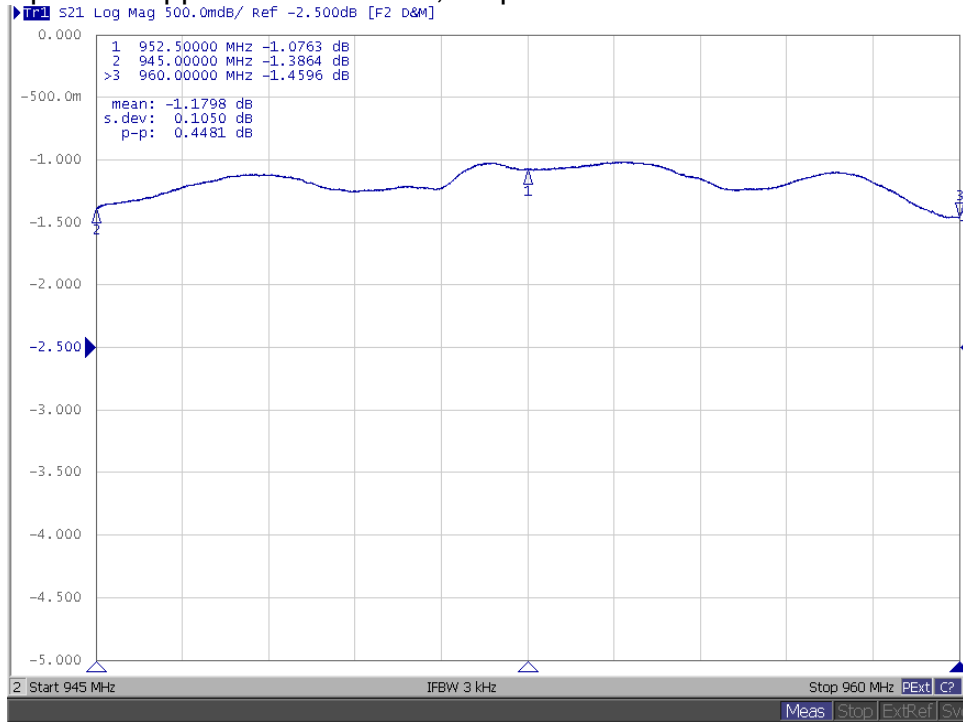

4. S21 Group delay: center 953MHz, span 50MHz

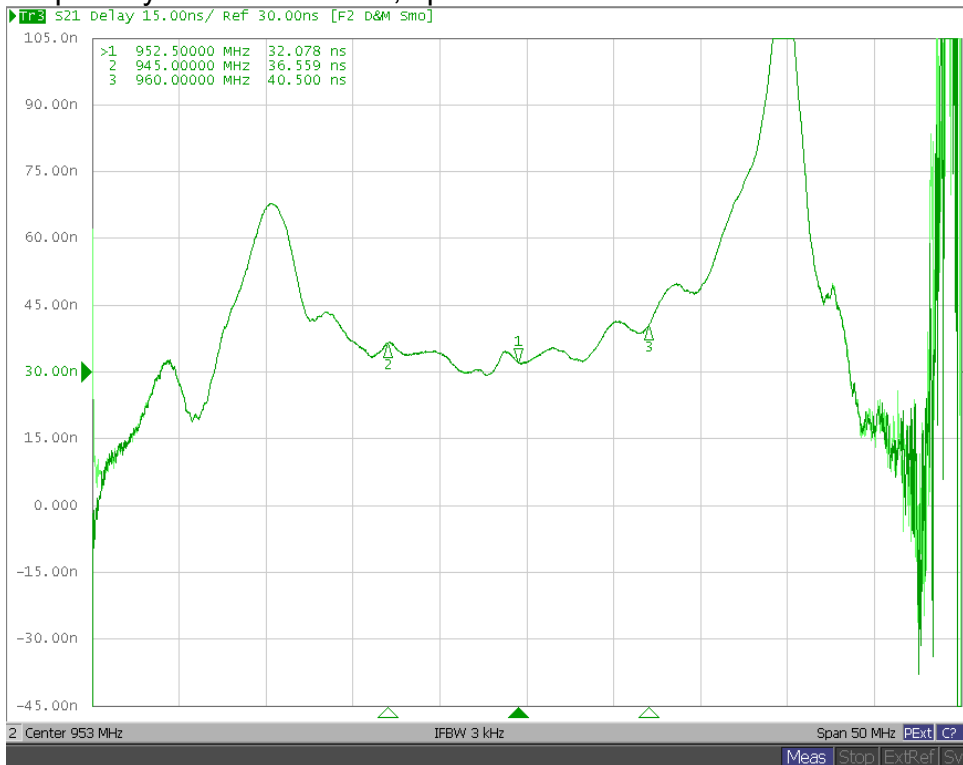

SAW Filter 952.50MHz
Part No: MP08738

Model No: TA1961A
Rev No: 1

5. Reflection Functions

S11 VSWR: center 953MHz, span 50MHz

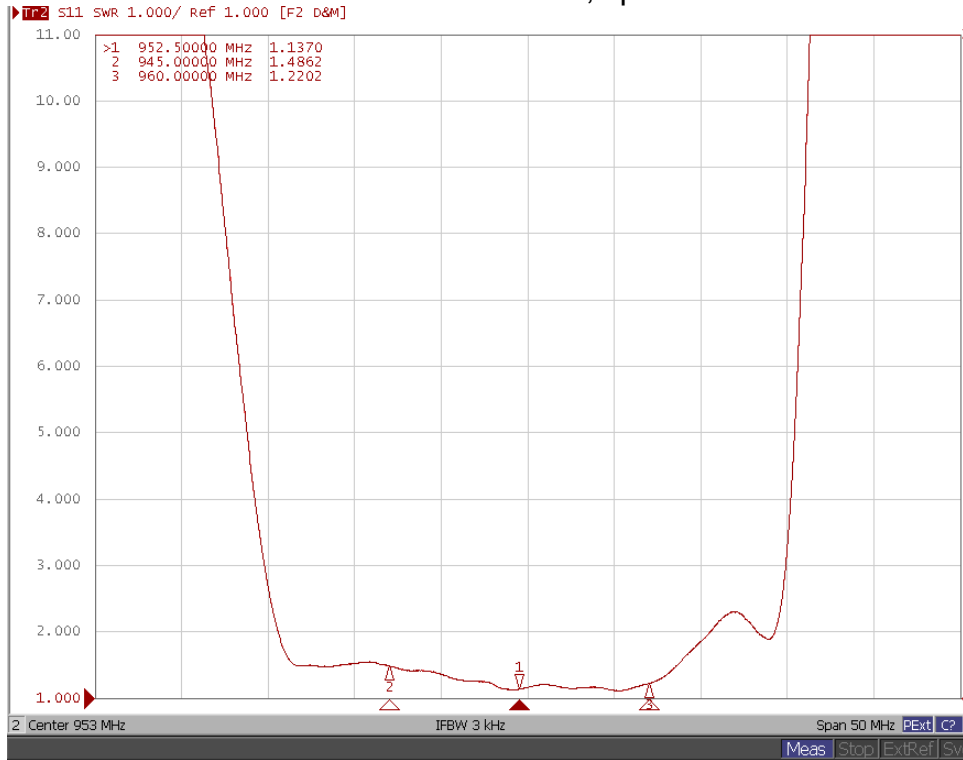

S22 VSWR: center 953MHz, span 50MHz

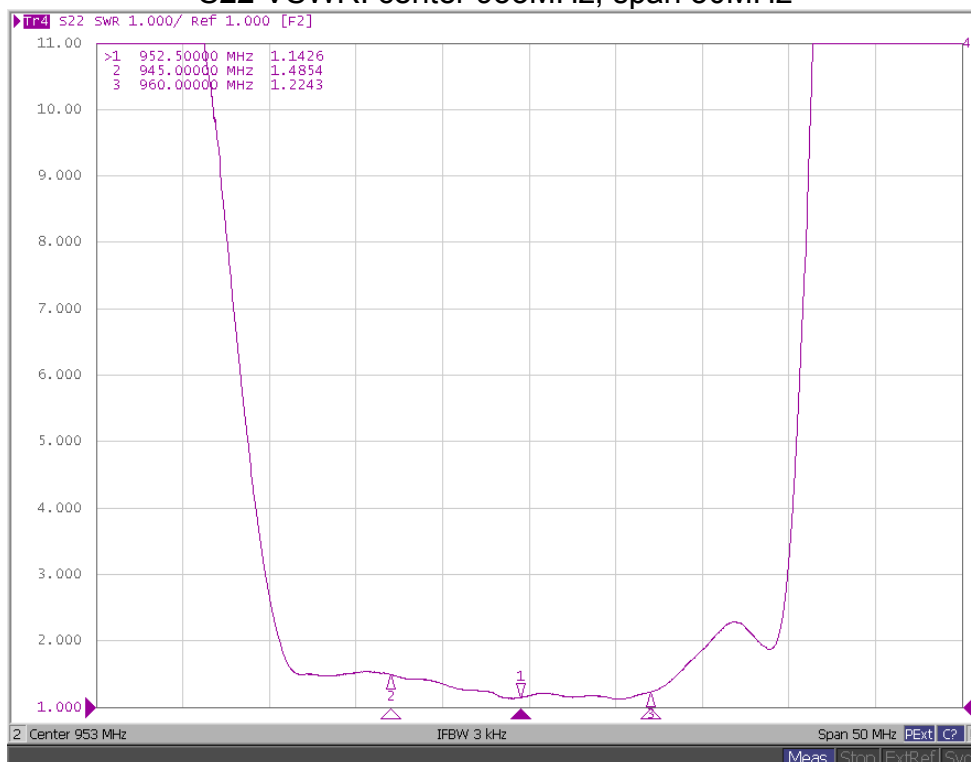

SAW Filter 952.50MHz
Part No: MP08738

Model No: TA1961A
Rev No: 1

E. OUTLINE DRAWING:

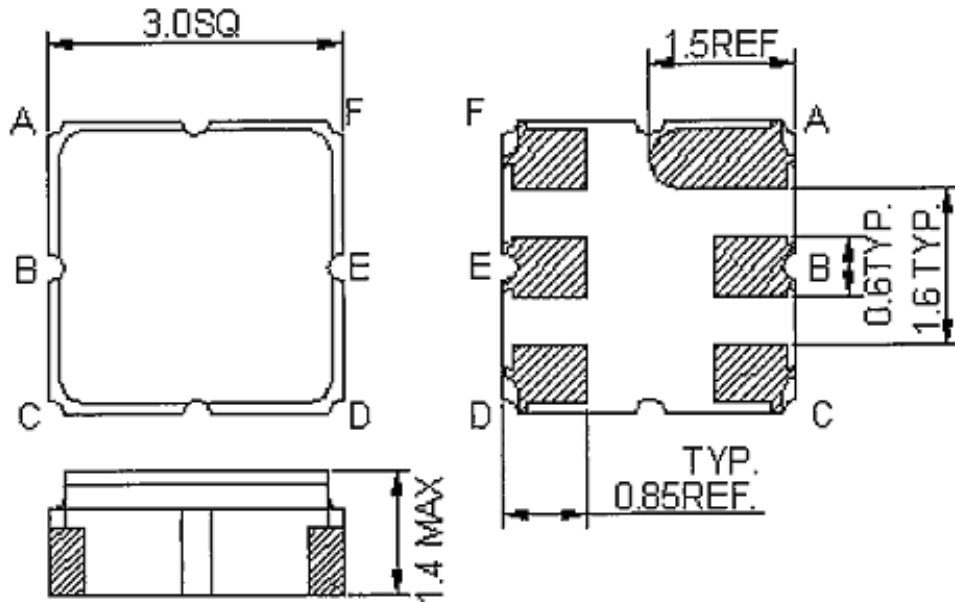

B: Input
E: Output
A, C, D, F: Ground
Unit: mm

F. PCB FOOTPRINT:

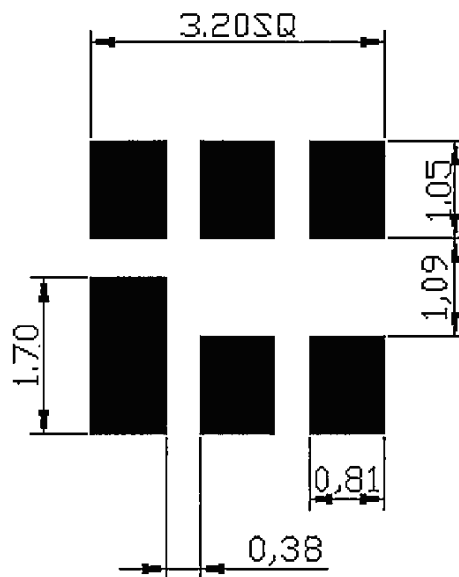

SAW Filter 952.50MHz
Part No: MP08738

Model No: TA1961A
Rev No: 1

G. PACKING:

1. Reel Dimension

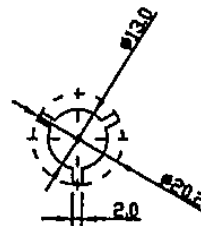
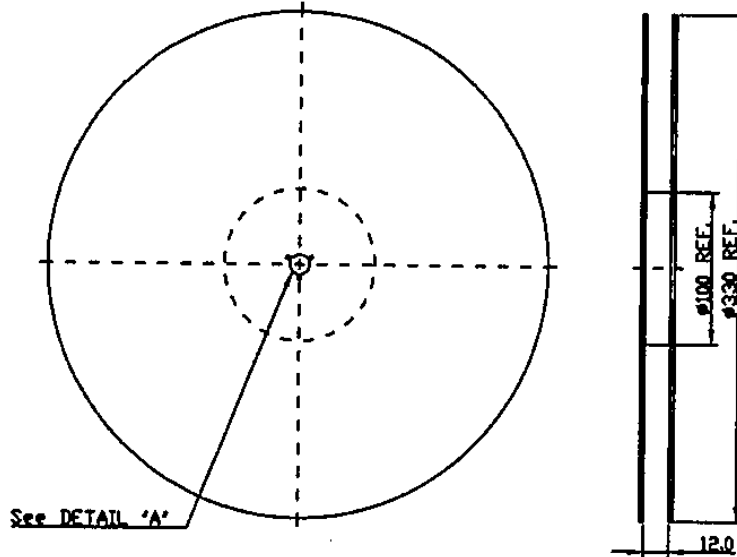

2. Tape Dimension

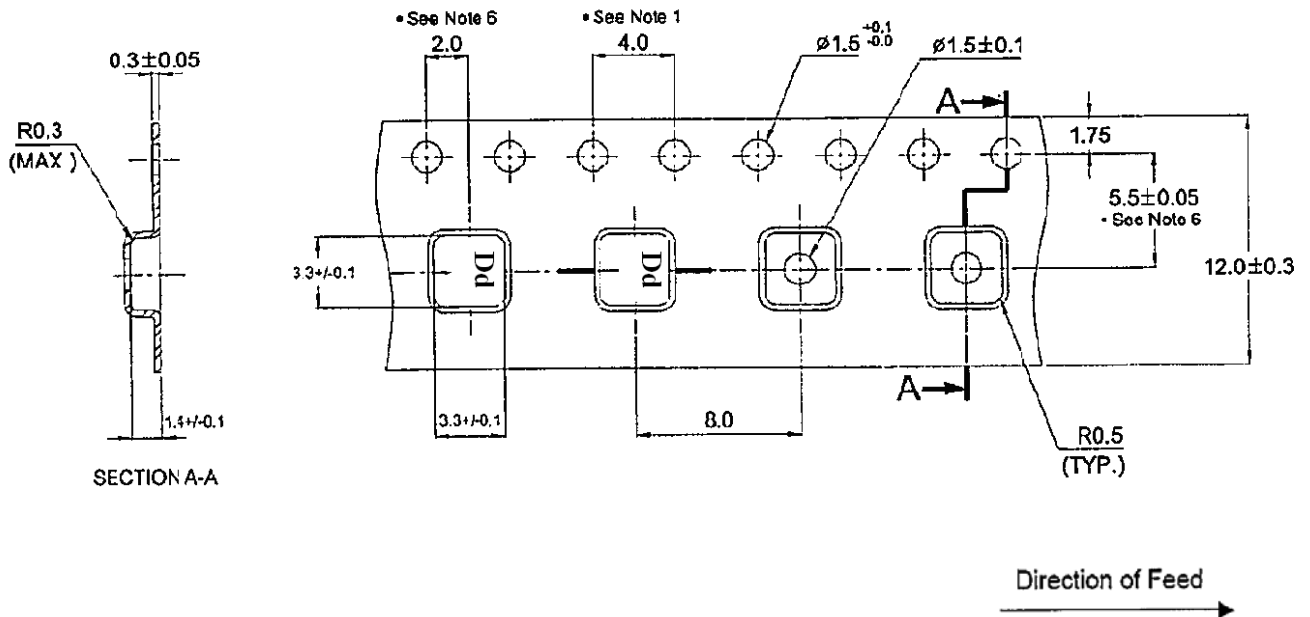

SAW Filter 952.50MHz
Part No: MP08738

Model No: TA1961A
Rev No: 1

H. RECOMMENDED REFLOW PROFILE:

1. Preheating shall be fixed at 150 ~ 180°C for 60 ~ 90 seconds.
2. Ascending time to preheating temperature 150°C shall be 30 seconds min.
3. Heating shall be fixed at 220°C for 50 ~ 80 seconds and at 260°C +0/-5°C peak (20 ~ 40 sec).
4. Time: 2 times.

