

GDX-1C

Watch Crystal for Dallas Semiconductors (now Maxim Integrated Products)

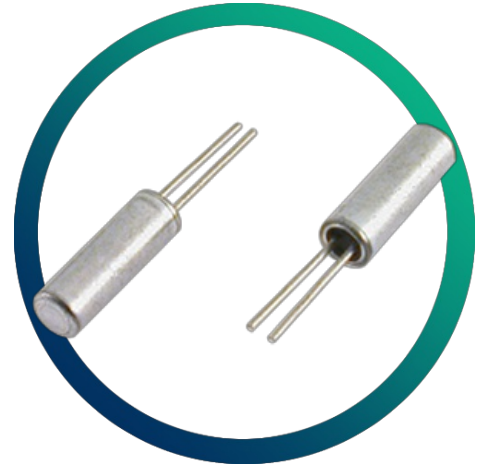

- Custom specification for Dallas RTCs
- 6pF load capacitance

CONFIGURABLE OPTIONS

Parameter	Option Code
Calibration tolerance	
Any	
±20ppm	
±10ppm	A

SPECIFICATIONS

Frequency	32.768kHz
Dimensions	2.0 x 6.0mm
Package	2x6mm cylinder
Operating temperature range	-10 to +60°C
Circuit condition	6pF
Static capacitance (C ₀)	1.2pF typ
Equivalent series resistance	42kΩ max
Ageing	±3ppm max first year
Drive level	1.0μW max
Turnover temperature (T ₀)	+25°C ±5°
Frequency / temp coefficient	-0.034ppm±0.006/°C ² typ

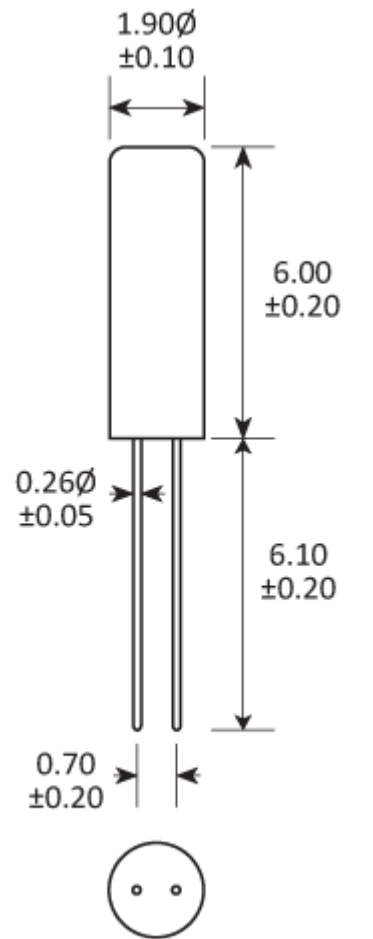
PACKAGE DRAWING

Dimensions in mm

ORDERING INFORMATION

To request a quotation for the GDx-1C please use the configurable options form to choose the options you require and then submit your configured product to our team. Our expert advisers are always happy to help with your requirements and can be contacted on +44 1460 256 100 or at sales@golledge.com.

Following product selection you will be issued with a seven character Golledge part number. Your Golledge part number is the internationally accepted Golledge manufacturing part number (MPN) that should be used for all project documentation, including bills of materials (BoMs) and purchase orders.

If you have any queries regarding any of our documentation our dedicated sales team will be happy to help.

COMPLIANCE

 Lead-free (< 0.1% by weight)

 RoHS compliant with no exemptions. [See our declaration](#)

 REACH compliant. [See our statement](#)

 Free of conflict minerals. [See our declaration](#)

 Free of Halogens. [See our declaration](#)

 Free of Ozone-depleting substances. [See our declaration](#)

HANDLING & STORAGE



Human Body Model (HBM) 1A (250V to <500V)



Moisture Sensitivity Level (MSL): 1 (or not applicable)