

# GMCF-21 21G20B

21.4MHz 4 pole crystal filter with  
20.0kHz 3dB bandwidth

- Comprehensive stocks
- Custom specifications available

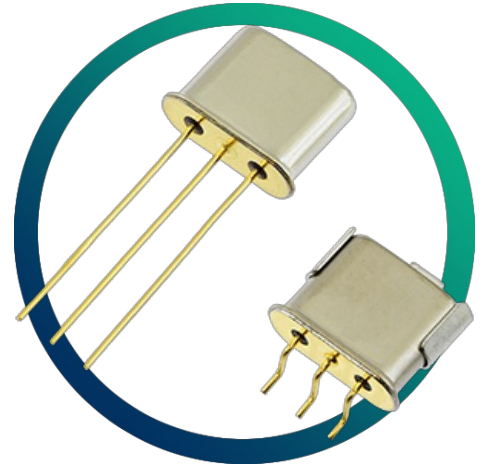

## CONFIGURABLE OPTIONS

Parameter	Option Code
Package	
Any	
UM-1/3Lx2 (leaded)	
UM-5/3Lx2 (leaded)	
UM-1JN/3Lx2 (SMT)	
UM-5JN/3Lx2 (SMT)	

**SPECIFICATIONS**

Centre frequency	21.4MHz
Dimensions	Package options available - see Package Drawing
Operating temperature range	-20 to +70°C
Number of poles	4
Pass band	-3dB @ ±10.0kHz min
Attenuation band	-40dB @ ±35.0kHz max
In-band ripple	1.0dB max
Insertion loss	2.5dB max
Guaranteed attenuation	-65dB max ±300 ~ ±1000kHz
Termination	1500Ω // 2.0pF
Coupling capacitance (C <sub>c</sub> )	6.5pF
Package style	UM-1/3Lx2, UM-5/3Lx2 (through-hole) UM-1JN/3Lx2, UM-5JN/3Lx2 (SMT)

**PACKAGE DRAWING**

## Package Options

## Through hole

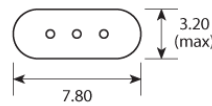
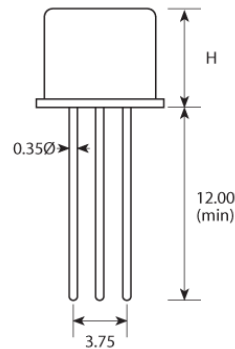

Package	Height H
UM-1/3L	8.00 max
UM-5/3L	6.00 max

## Surface mounted

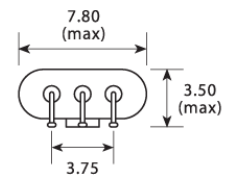
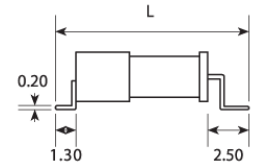
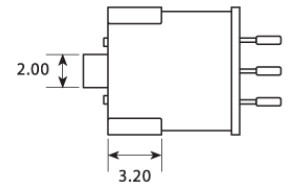

Package	Length L
UM-1JN/3L	12.50 max
UM-5JN/3L	10.50 max

Dimensions in mm

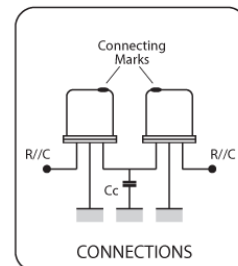

## ORDERING INFORMATION

To request a quotation for the GMCF-21 21G20B please use the configurable options form to choose the options you require and then submit your configured product to our team. Our expert advisers are always happy to help with your requirements and can be contacted on +44 1460 256 100 or at [sales@golledge.com](mailto:sales@golledge.com).

Following product selection you will be issued with a seven character Golledge part number. Your Golledge part number is the internationally accepted Golledge manufacturing part number (MPN) that should be used for all project documentation, including bills of materials (BoMs) and purchase orders.

If you have any queries regarding any of our documentation our dedicated sales team will be happy to help.

## TAPE & REEL SPECIFICATION

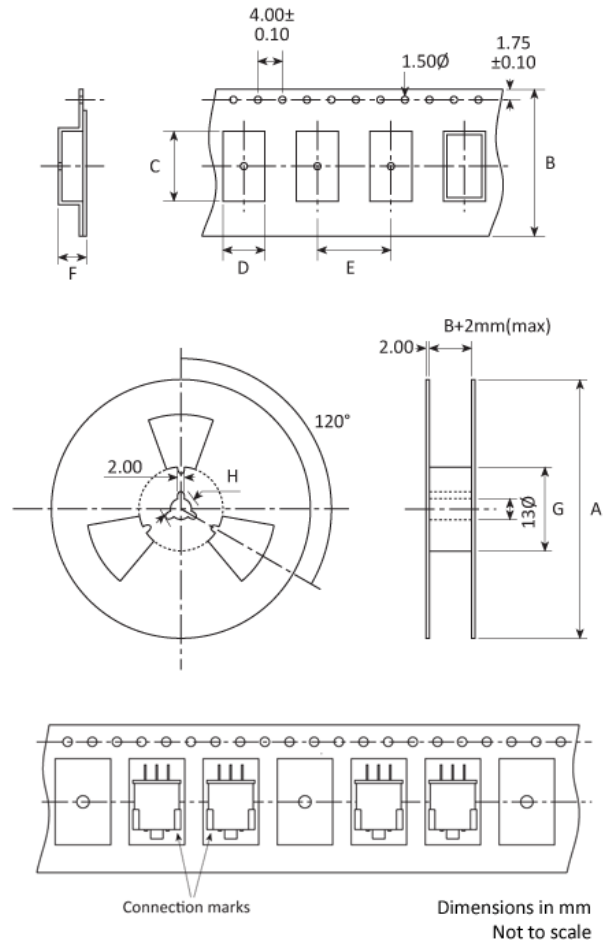

UM-1J - A:330 B:24 C:14.1 D:8.4 E:12 F:4.6 G:80 H:21

UM-5J - A:180 B:24 C:12.5 D:8.4 E:12 F:4.4 G:60 H:21

**HANDLING & STORAGE**

Human Body Model (HBM) 1A (250V to &lt;500V)



Moisture Sensitivity Level (MSL): 1 (or not applicable)

**CONSTRUCTION**

Resistance weld

Bulk-packed 4-pole filters: Pair alignment when boxed.

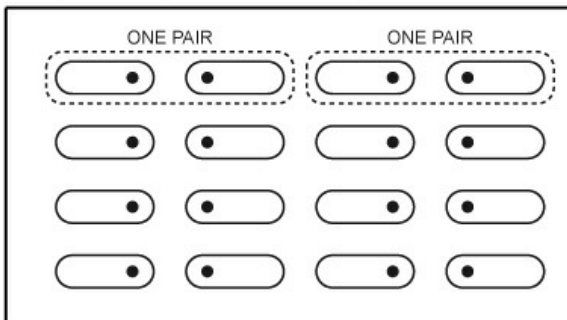

These filters are individually matched pairs. One filter is composed of two physical units, which have been factory-matched for optimum performance.

DO NOT MIX. Unmatched pairs will offer impaired performance.

For filters supplied in boxes, please refer to the above diagram.

Matched pairs may also be supplied in individual bags.

## COMPLIANCE

---



Lead-free (< 0.1% by weight)



RoHS compliant with no exemptions. [See our](#)

[declaration](#)



REACH compliant. [See our statement](#)



Free of conflict minerals. [See our declaration](#)



Free of Halogens. [See our declaration](#)



Free of Ozone-depleting substances. [See our](#)

[declaration](#)