

GRX-220

Automotive Crystal (AEC-Q200)

- AEC-Q200 qualified for automotive applications
- Vacuum seal for excellent long-term stability
- High reliability at low cost
- Metal lid can be grounded to minimise EMI



CONFIGURABLE OPTIONS

Parameter	Option Code
Frequency	
Calibration tolerance	
Any	
±10ppm	1
±15ppm	P
±20ppm	2
Temperature stability	
Any	
±15ppm	P
±20ppm	2
±50ppm	5
±100ppm	C
Operating temperature range	
Any	
-40 to +85 °C	4
-40 to +125 °C	A
Circuit condition	
Any	
8pF	M
10pF	A
12pF	B
16pF	D
Oscillation mode	
Fundamental	F

SPECIFICATIONS

Frequency range	16.0 ~ 26.0MHz
Dimensions	2.0 x 1.6 x 0.55mm
Storage temperature range	-40 to +125°C
Static capacitance (C ₀)	5pF max
Equivalent series resistance	150Ω max (16.0 ~ 19.99MHz) 100Ω max (20.0 ~ 26.0MHz)
Ageing	±3ppm max first year
Test drive level	10μW typ, 100μW max
Soldering condition	260°C, 10 sec x2 max
Qualification	AEC-Q200 (Automotive)

PACKAGE DRAWING

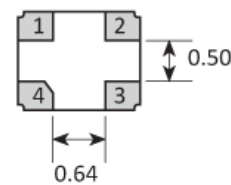
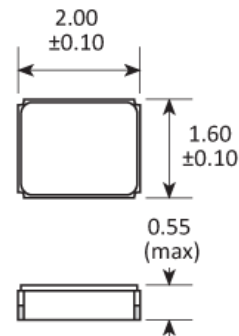

SOLDER PAD LAYOUT

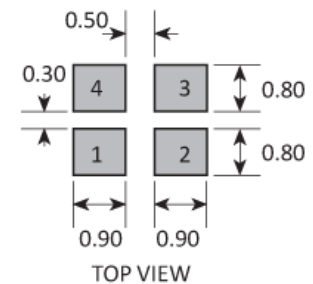

PAD	CONNECTION
1	Crystal
2	Ground & lid
3	Crystal
4	Ground & lid

Dimensions in mm

ORDERING INFORMATION

To request a quotation for the GRX-220 please use the configurable options form to choose the options you require and then submit your configured product to our team. Our expert advisers are always happy to help with your requirements and can be contacted on +44 1460 256 100 or at sales@golledge.com.

Following product selection you will be issued with a seven character Golledge part number. Your Golledge part number is the internationally accepted Golledge manufacturing part number (MPN) that should be used for all project documentation, including bills of materials (BoMs) and purchase orders.

If you have any queries regarding any of our documentation our dedicated sales team will be happy to help.

APPLICATIONS

Vehicle telematics
 Connected car
 Remote keyless entry (RKE)
 Audio (DAB/Bluetooth)
 Camera

MARKING

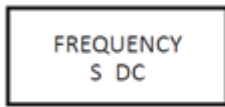

Marking type: Laser

DC = Date Code in YM, eg. "GF" = Jun 2017

	A	B	C	D	E	F	G	H	J	K	L	M
Y	1	2	3	4	5	6	7	8	9	0		
M	Jan	Feb	Mar	Apr	May	Jun	Jul	Aug	Sep	Oct	Nov	Dec

SOLDERING PROFILE

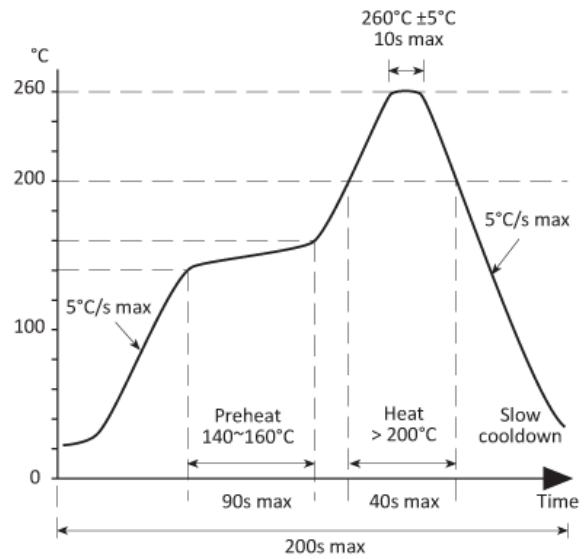

TAPE & REEL SPECIFICATION

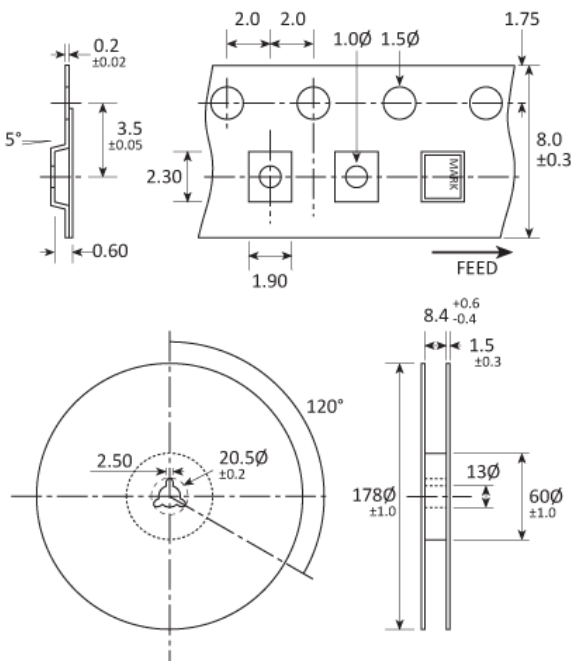

Dimensions in mm

HANDLING & STORAGE



Human Body Model (HBM) 1A (250V to <500V)





Moisture Sensitivity Level (MSL): 1 (or not applicable)

CONSTRUCTION

Ceramic body with gold-plated pads
Metal lid, seam sealed

COMPLIANCE

 Lead-free (< 0.1% by weight)

 RoHS compliant with no exemptions. [See our declaration](#)

 REACH compliant. [See our statement](#)

 Free of conflict minerals. [See our declaration](#)

 Free of Halogens. [See our declaration](#)

 Free of Ozone-depleting substances. [See our declaration](#)