

GSF-72 21S20A

21.4MHz 2 pole crystal filter with 20.0kHz 3dB bandwidth

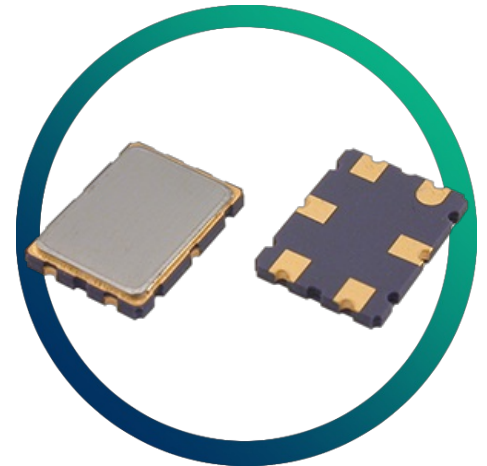

- Other frequencies up to 70MHz available
- Custom specifications available
- Miniature SM package

CONFIGURABLE OPTIONS

Parameter

Option Code

The GSF-72 21S20A has no configurable options.

Please see the specifications table for more details or contact our team today if you have other specification requirements.

SPECIFICATIONS

Centre frequency	21.4MHz
Dimensions	7.2 x 5.2 x 1.2mm
Operating temperature range	-20 to +70°C
Number of poles	2
Pass band	-3dB @ ±10.0kHz min
Attenuation band	-15dB @ ±34.0kHz max
In-band ripple	1.0dB max
Insertion loss	2.0dB max
Guaranteed attenuation	-50dB max -910 ±10kHz
Termination	1800Ω // 0.5pF
Number of units	1

PACKAGE DRAWING

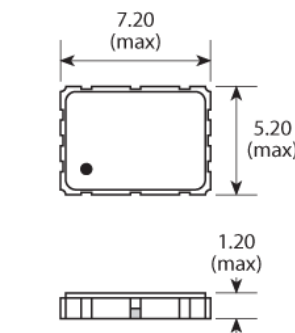

PAD	CONNECTION
1	Ground
2	Not connected
3	In / Out
4	Ground
5	Not connected
6	Out / In

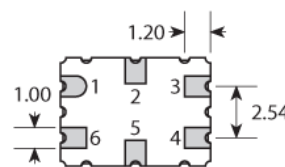

SOLDER PAD LAYOUT

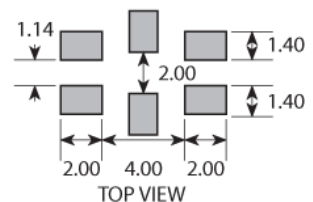

Dimensions in mm

ORDERING INFORMATION

To request a quotation for the GSF-72 21S20A please use the configurable options form to choose the options you require and then submit your configured product to our team. Our expert advisers are always happy to help with your requirements and can be contacted on +44 1460 256 100 or at sales@golledge.com.

Following product selection you will be issued with a seven character Golledge part number. Your Golledge part number is the internationally accepted Golledge manufacturing part number (MPN) that should be used for all project documentation, including bills of materials (BoMs) and purchase orders.

If you have any queries regarding any of our documentation our dedicated sales team will be happy to help.

SOLDERING PROFILE

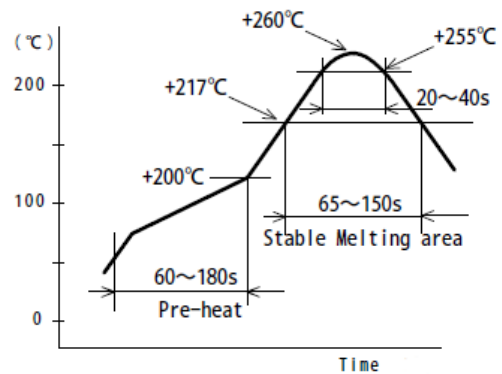

TAPE & REEL SPECIFICATION

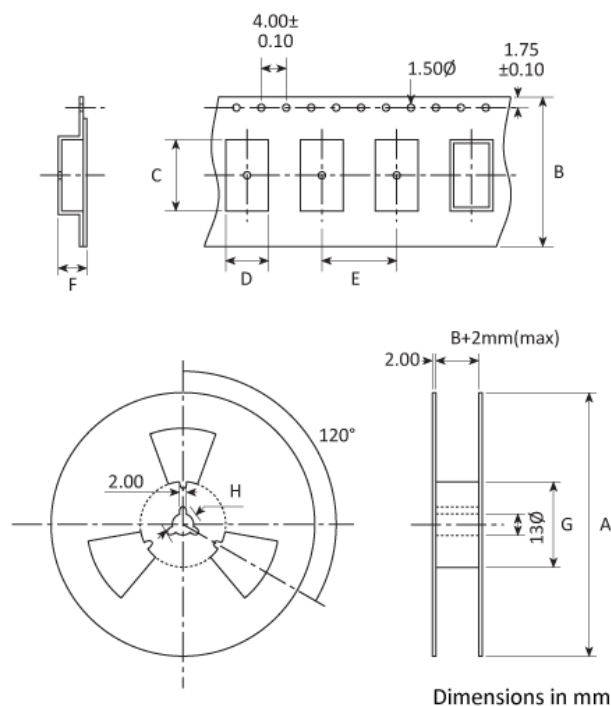

A:250 B:17.5 C:7.9 D:5.4 E:8 F:1.7 G:80 H:21

HANDLING & STORAGE



Human Body Model (HBM) 1A (250V to <500V)





Moisture Sensitivity Level (MSL): 1 (or not applicable)

CONSTRUCTION

Ceramic base with metal lid

COMPLIANCE

 Lead-free (< 0.1% by weight)

 RoHS compliant with no exemptions. [See our declaration](#)

 REACH compliant. [See our statement](#)

 Free of conflict minerals. [See our declaration](#)

 Free of Halogens. [See our declaration](#)

 Free of Ozone-depleting substances. [See our declaration](#)