

GTXO-C99V

CMOS TCXO Voltage Control High
Precision Low g-Sensitivity Low
Phase Noise

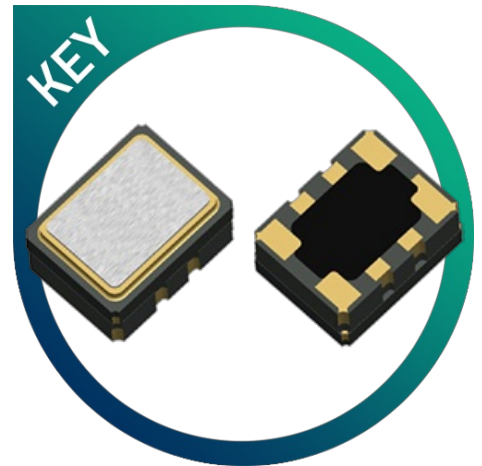

- Stratum 3
- Low g-Sensitivity <math><0.3\text{ppb/g}</math>
- High Precision <math>< \pm 0.1\text{ppm}</math>
- CMOS output
- Miniature SM package

CONFIGURABLE OPTIONS

Parameter	Option Code
Frequency	
Frequency stability	
Any	
$\pm 0.1\text{ppm}$ (-20 to +70°C only)	B
$\pm 0.2\text{ppm}$	P
Temperature range	
Any	
-20 to +70°C	N
-30 to +85°C	S
-40 to +85°C	I
Supply voltage (V_{DD})	
Any	
+3.3V $\pm 5\%$	L
+2.5V $\pm 5\%$	J

SPECIFICATIONS

Frequency range	5.0 ~ 52.0MHz
Dimensions	3.2 x 2.5 x 1.58
Storage temperature range	-55 to +125 °C
Supply current	7.5mA max
Driving ability	15pF CMOS
Waveform symmetry	45:55 @ 50%V _{DD}
Logic levels	'0' level = 10%V _{DD} max '1' level = 90%V _{DD} min
Start up time	5ms max
Frequency adjustment	None ±5ppm, +1.5V ±1.0V
Phase noise (typ @ 10.0MHz)	-130dBc/Hz @ 100Hz -145dBc/Hz @ 1kHz -154dBc/Hz @ 10kHz
g-Sensitivity	0.3ppb/g typ., 0.5ppb/g max.
Frequency stability over 20 years *1 see note below	±4.6ppm max
Holdover stability *2 see note below	0.37ppm

***1 Stability is inclusive of calibration @25 °C, reflow, supply voltage and load variation, 20 years ageing and frequency stability over temperature**

***2 Holdover stability is inclusive of frequency stability over temperature, supply voltage variation, and 24 hour ageing**

PACKAGE DRAWING

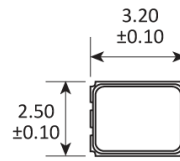

NOTE: To ensure optimal oscillator performance, place a by-pass capacitor of 0.1μF as close to the part as possible between V_{dd} and GND pads, plus one of 0.033μF from pad 7 to ground.

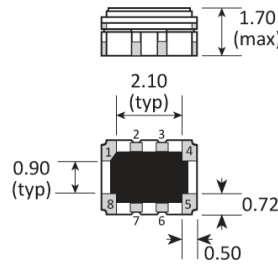

SOLDER PAD LAYOUT

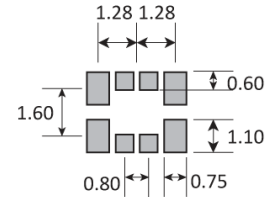

PAD	CONNECTION
1	Control voltage
2	Do not connect
3	Do not connect
4	Ground (GND)
5	Output 1
6	Enable / disable
7	Filter
8	Supply (V _{dd})

Dimensions in mm

ORDERING INFORMATION

To request a quotation for the GTXO-C99V please use the configurable options form to choose the options you require and then submit your configured product to our team. Our expert advisers are always happy to help with your requirements and can be contacted on +44 1460 256 100 or at sales@golledge.com.

Once we've received your request our expert team will then produce a quotation tailored to meet your needs using the option codes you've selected.

Following product selection you will be issued with a seven character Golledge part number. Your Golledge part number is the internationally accepted Golledge manufacturing part number (MPN) that should be used for all project documentation, including bills of materials (BoMs) and purchase orders.

If you have any queries regarding any of our documentation our dedicated sales team will be happy to help.

MARKING

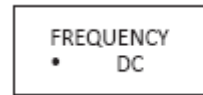

- Pin 1
- Marking type: Laser
- DC = Date code

SOLDERING PROFILE

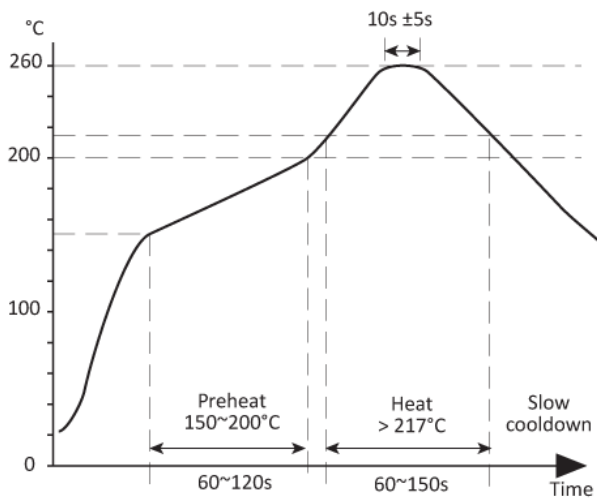

TAPE & REEL SPECIFICATION

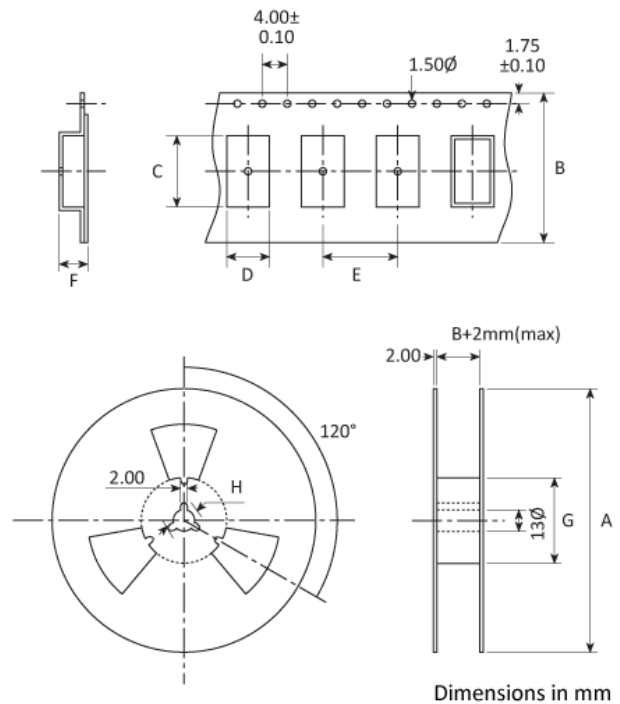

HANDLING & STORAGE



Human Body Model (HBM) 1A (250V to <500V)



Moisture Sensitivity Level (MSL): 1 (or not applicable)

COMPLIANCE



Lead-free (< 0.1% by weight)



RoHS compliant with no exemptions. [See our declaration](#)



REACH compliant. [See our statement](#)



Free of conflict minerals. [See our declaration](#)



Free of Halogens. [See our declaration](#)



Free of Ozone-depleting substances. [See our declaration](#)