

# GWX-1610

## 1610 Package 32.768kHz Watch Crystal

- Competitive pricing for volume applications
- Ultra low profile - 0.5mm high
- Light weight miniature package
- Vacuum sealed for high stability



### CONFIGURABLE OPTIONS

Parameter	Option Code
Calibration tolerance	
±20ppm	
Circuit condition	
Any	
6pF	
7pF	
9pF	
12.5pF	

### SPECIFICATIONS

Frequency	32.768kHz
Dimensions	1.6 x 1.0 x 0.5mm
Operating temperature range	-40 to +85°C
Storage temperature range	-55 to +125°C
Static capacitance (C <sub>0</sub> )	1.2pF typ
Equivalent series resistance	90kΩ max @ 25°C
Ageing	±3ppm max first year
Drive level	1.0μW max
Turnover temperature (T <sub>0</sub> )	+25°C ±5°C
Frequency / temp coefficient	-0.036ppm/°C <sup>2</sup> typ

### PACKAGE DRAWING

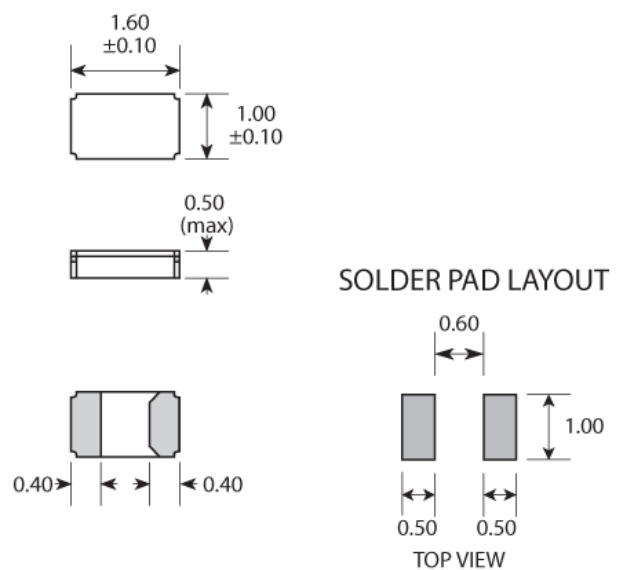

Dimensions in mm

**ORDERING INFORMATION**

To request a quotation for the GWX-1610 please use the configurable options form to choose the options you require and then submit your configured product to our team. Our expert advisers are always happy to help with your requirements and can be contacted on +44 1460 256 100 or at [sales@golledge.com](mailto:sales@golledge.com).

Following product selection you will be issued with a seven character Golledge part number. Your Golledge part number is the internationally accepted Golledge manufacturing part number (MPN) that should be used for all project documentation, including bills of materials (BoMs) and purchase orders.

If you have any queries regarding any of our documentation our dedicated sales team will be happy to help.

**SOLDERING PROFILE**

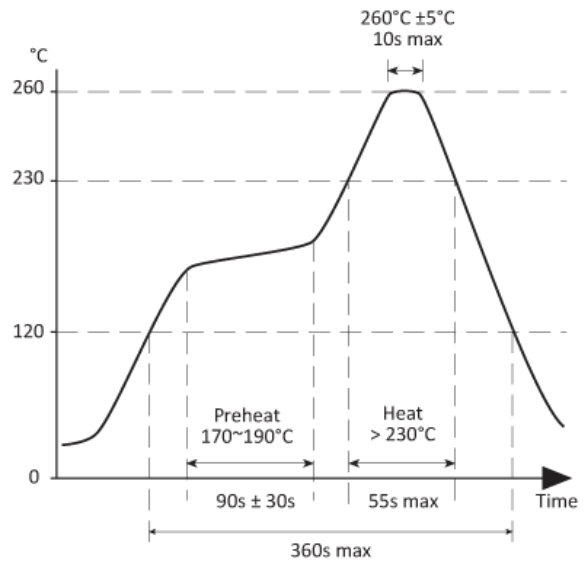

**TAPE & REEL SPECIFICATION**

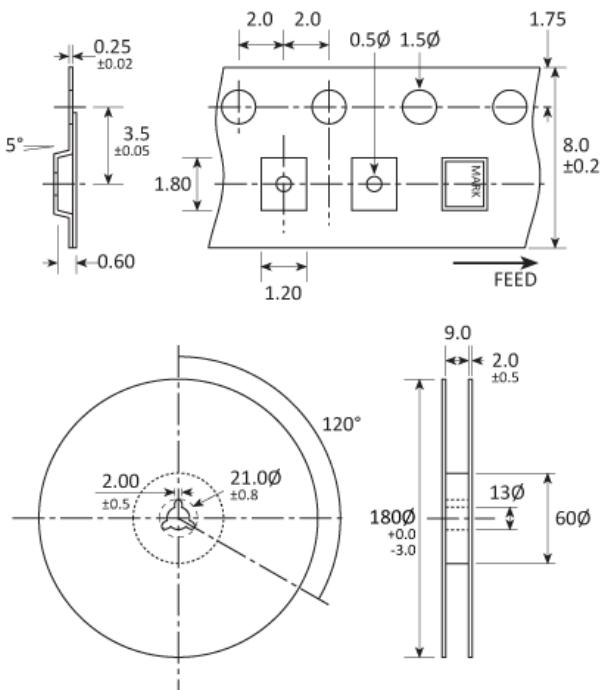

Dimensions in mm

**HANDLING & STORAGE**



Human Body Model (HBM) 1A (250V to <500V)



Moisture Sensitivity Level (MSL): 1 (or not applicable)

## CONSTRUCTION

---

Ceramic body with gold-plated pads  
Metal lid, vacuum sealed

## COMPLIANCE

---

Please refer to our **DOCUMENTS** section for more information.

 Lead-free (< 0.1% by weight)

 RoHS compliant with no exemptions.

 REACH compliant.

 Free of conflict minerals.

 Free from halogens.

 Free from ozone-depleting substances.