

# GXO-3204E

## 1.2V CMOS Oscillator

- Competitive pricing for high volumes
- Miniature ceramic package with metal lid
- Industry standard footprint
- Enable / disable tristate function



### CONFIGURABLE OPTIONS

| Parameter                   | Option Code |
|-----------------------------|-------------|
| Frequency                   |             |
| Frequency stability         |             |
| * see note below            |             |
| Any                         |             |
| ±100ppm max                 |             |
| ±50ppm max                  | B           |
| ±25ppm max                  | A           |
| Operating temperature range |             |
| Any                         |             |
| -20 to +70 °C               |             |
| -40 to +85 °C               | I           |
| -40 to +125 °C              | H           |

**SPECIFICATIONS**

|                             |  |
|-----------------------------|--|
| Frequency range             | 20.0 ~ 50.0MHz   |
| Dimensions                  | 2.5 x 2.0 x 1.0mm  |
| Storage temperature range   | -55 to +125 °C   |
| Supply voltage ( $V_{DD}$ ) | +1.2V ( $\pm 10\%$ )   |
| Supply current              | 20mA max   |
| Logic levels                | '0' level = 10% $V_{DD}$ max<br>'1' level = 90% $V_{DD}$ min |
| Start up time               | 10ms max   |
| Waveform symmetry           | 45:55 @ 50% $V_{DD}$   |
| Driving ability             | 15pF CMOS  |
| Rise / fall time            | 10ns max   |
| Enable / disable function   | Tristate (control via pad 1)                                 |
| Ageing                      | $\pm 5$ ppm / year max                                       |

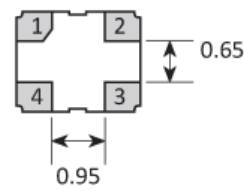
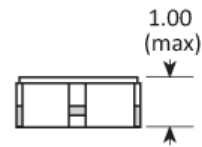
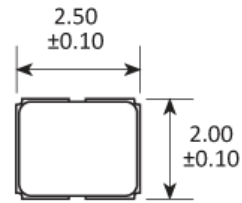
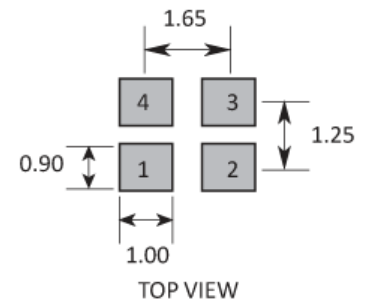
**PACKAGE DRAWING**

**SOLDER PAD LAYOUT**

| PAD | CONNECTION       |
|-----|------------------|
| 1   | Enable / disable |
| 2   | Ground           |
| 3   | Output           |
| 4   | Supply           |

Dimensions in mm

## ORDERING INFORMATION

To request a quotation for the GXO-3204E please use the configurable options form to choose the options you require and then submit your configured product to our team. Our expert advisers are always happy to help with your requirements and can be contacted on +44 1460 256 100 or at [sales@golledge.com](mailto:sales@golledge.com).

Following product selection you will be issued with a seven character Golledge part number. Your Golledge part number is the internationally accepted Golledge manufacturing part number (MPN) that should be used for all project documentation, including bills of materials (BoMs) and purchase orders.

If you have any queries regarding any of our documentation our dedicated sales team will be happy to help.

## ENABLE / DISABLE FUNCTION

| Input (pad 1) | Output (pad 3) |
|---------------|----------------|
| Open          | Enabled        |
| '1' level     | Enabled        |
| '0' level     | High Impedance |

## MARKING

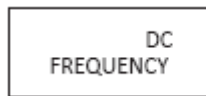

Marking type: Laser

DC = Date Code in YM, eg. "GF" = Jun 2017

|   | A   | B   | C   | D   | E   | F   | G   | H   | J   | K   | L   | M   |
|---|-----|-----|-----|-----|-----|-----|-----|-----|-----|-----|-----|-----|
| Y | 1   | 2   | 3   | 4   | 5   | 6   | 7   | 8   | 9   | 0   |     |     |
| M | Jan | Feb | Mar | Apr | May | Jun | Jul | Aug | Sep | Oct | Nov | Dec |

## SOLDERING PROFILE

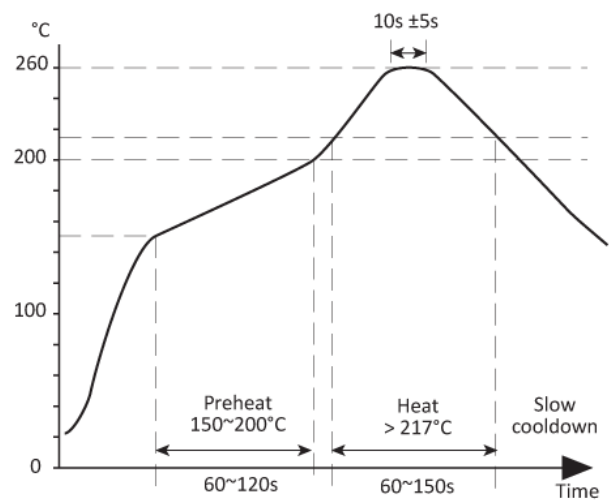

Lead free solderability limits: 260°C ±5°C x 10s ±5s x 2.

## TAPE & REEL SPECIFICATION

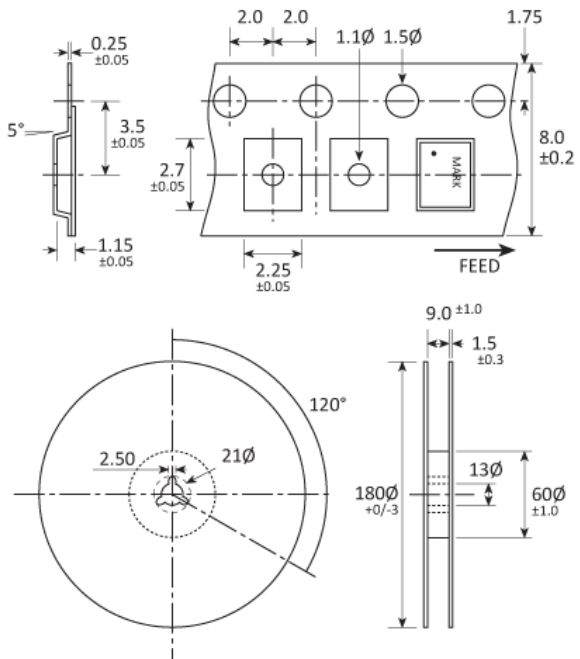

Dimensions in mm

## CONSTRUCTION

Ceramic body with gold-plated pads Metal lid, seam sealed

## HANDLING & STORAGE



Human Body Model (HBM) 1A (250V to <500V)



Moisture Sensitivity Level (MSL): 1 (or not applicable)

## COMPLIANCE



Lead-free (< 0.1% by weight)



RoHS compliant with no exemptions. [See our declaration](#)



REACH compliant. [See our statement](#)



Free of conflict minerals. [See our declaration](#)



Free of Halogens. [See our declaration](#)



Free of Ozone-depleting substances. [See our declaration](#)