

GXO-3300G

High Frequency, Tight Stability 1.8V Oscillator with 3225 Package

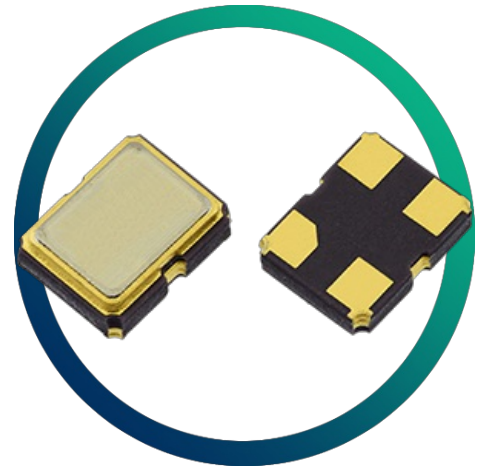

- High precision with tight stability options
- Wide operating temperature ranges
- High frequency fundamental - no multiplier
- Low & medium volumes also available
- Enable / disable tristate function

CONFIGURABLE OPTIONS

Parameter	Option Code
Frequency	
Frequency stability * see note below	
Any	
±2.5ppm max over -40 to +85°C	H
±5.0ppm max over -40 to +85°C	G
±10ppm max over -40 to +85°C	F
±15ppm max over -40 to +85°C	E
±20ppm max over -40 to +105°C	D
±25ppm max over -40 to +125°C	A

* Frequency stability is inclusive of calibration @ 25°C, operating temperature range, supply voltage change, load change, shock and vibration. Option H inclusive of calibration @ 25°C and operating temperature range only.

SPECIFICATIONS

Frequency range	10.0 ~ 160MHz
Dimensions	3.2 x 2.5 x 1.1mm
Storage temperature range	-55 to +125 °C
Supply voltage (V_{DD})	+1.8V ($\pm 5\%$)
Supply current	11mA max (10.0 ~ 80.0MHz) 20mA max (80.0 ~ 160MHz)
Logic levels	'0' level = 10% V_{DD} max '1' level = 90% V_{DD} min
Start up time	5ms max
Waveform symmetry	45:55 max @ 50% V_{DD}
Driving ability	15pF CMOS
Rise / fall time (10~90% V_{DD})	6ns max (≤ 40.0 MHz) 3ns max (> 40.0 MHz)
Enable / disable function	Tristate (control via pad 1)
Stand-by current	10 μ A max
Phase jitter RMS	0.3ps typ (12kHz ~ 20.0MHz)

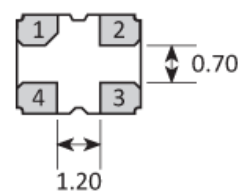
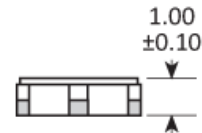
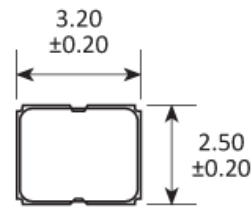
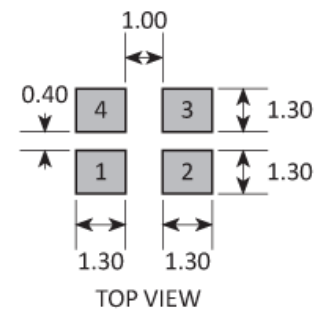
PACKAGE DRAWING

SOLDER PAD LAYOUT

PAD	CONNECTION
1	Enable / disable
2	Ground
3	Output
4	Supply

Dimensions in mm

ORDERING INFORMATION

To request a quotation for the GXO-3300G please use the configurable options form to choose the options you require and then submit your configured product to our team. Our expert advisers are always happy to help with your requirements and can be contacted on +44 1460 256 100 or at sales@golledge.com.

Following product selection you will be issued with a seven character Golledge part number. Your Golledge part number is the internationally accepted Golledge manufacturing part number (MPN) that should be used for all project documentation, including bills of materials (BoMs) and purchase orders.

If you have any queries regarding any of our documentation our dedicated sales team will be happy to help.

ENABLE / DISABLE FUNCTION

Input (pad 1)	Output (pad 3)
Open	Enabled
'1' level	Enabled
'0' level	High Impedance

MARKING

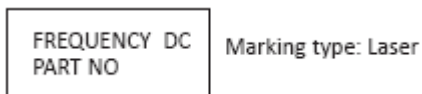

DC = Date Code in YM, eg. "GF" = Jun 2017

	A	B	C	D	E	F	G	H	J	K	L	M
Y	1	2	3	4	5	6	7	8	9	0		
M	Jan	Feb	Mar	Apr	May	Jun	Jul	Aug	Sep	Oct	Nov	Dec

SOLDERING PROFILE

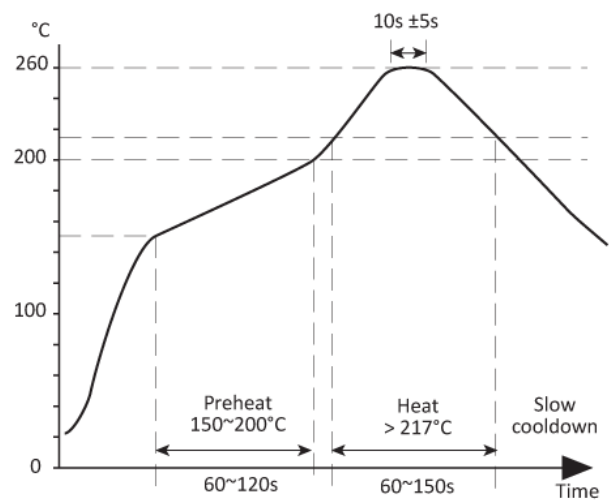

Lead free solderability limits: 260°C ±5°C x 10s ±5s x 2.

TAPE & REEL SPECIFICATION

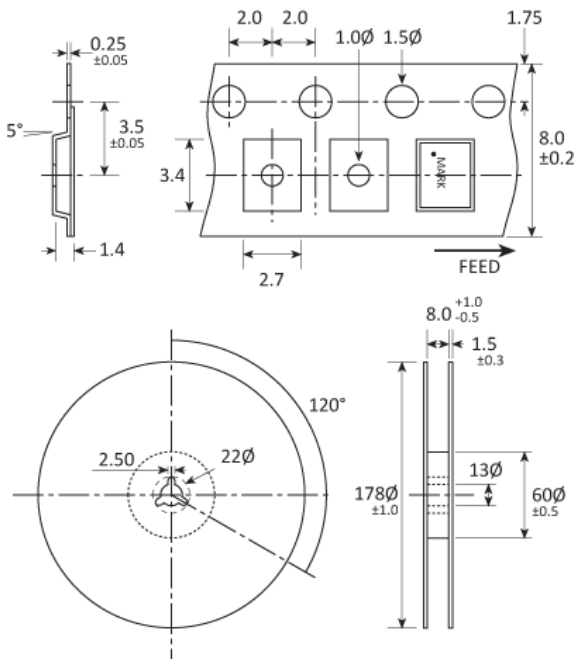

Dimensions in mm

CONSTRUCTION

Ceramic body with gold-plated pads
Metal lid, seam sealed

HANDLING & STORAGE



Human Body Model (HBM) 1A (250V to <500V)



Moisture Sensitivity Level (MSL): 1 (or not applicable)

COMPLIANCE

Please refer to our **DOCUMENTS** section for more information.



Lead-free (< 0.1% by weight)



RoHS compliant with no exemptions.



REACH compliant.



Free of conflict minerals.



Free from halogens.



Free from ozone-depleting substances.