

GXO-L71G

1.8V LVDS Oscillator for High Speed Data Transfer with Power Saving

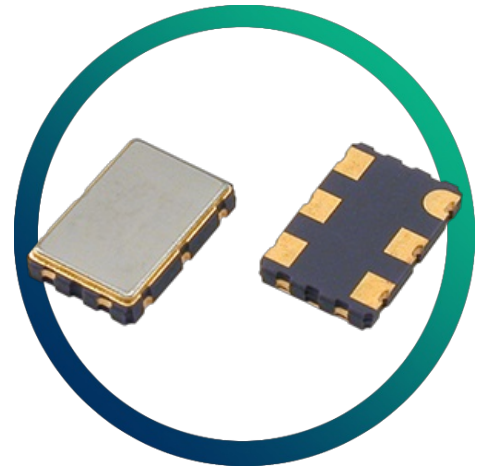

- LVDS output
- Low phase jitter
- Enable / disable tristate function
- Power saving function
- Fast rise / fall times

CONFIGURABLE OPTIONS

Parameter	Option Code
Frequency	
Frequency stability * see note below	
Any	
±100ppm	
±50ppm	B
±25ppm	A
Operating temperature range	
Any	
-10 to +70°C	
-40 to +85°C	I

* Frequency stability is inclusive of calibration @ 25°C, operating temperature range, supply voltage change, load change, shock and vibration.

SPECIFICATIONS

Frequency range	75.0 ~ 315MHz
Dimensions	7.5 x 5.0 x 1.5mm
Storage temperature range	-55 to +125°C
Supply voltage (V_{DD})	+1.8V ($\pm 5\%$)
Supply current	63mA max
Output	LVDS
Offset voltage	1.25V typ
Differential output voltage	0.247V ~ 0.454V (0.33V typ)
Output load	100 Ω
Start up time	10ms max
Waveform symmetry	45:55 max @ 50% V_{p-p}
Rise / fall time	0.7ns max (20 ~ 80% V_{p-p})
Enable / disable function	Tristate (control via pad 1)
Output enable / disable time	10 ms / 200ns max
Stand-by current	30 μ A max
Phase jitter RMS	1ps max (0.3ps typ), 12kHz~20MHz

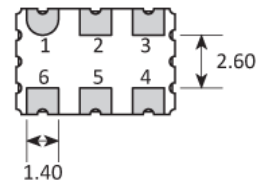
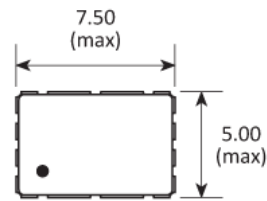
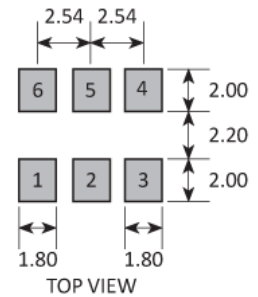
PACKAGE DRAWING

SOLDER PAD LAYOUT

PAD	CONNECTION
1	Enable/Disable
2	Not connected
3	Ground
4	Output 1
5	Output 2
6	Supply

Dimensions in mm

ORDERING INFORMATION

To request a quotation for the GXO-L71G please use the configurable options form to choose the options you require and then submit your configured product to our team. Our expert advisers are always happy to help with your requirements and can be contacted on +44 1460 256 100 or at sales@golledge.com.

Following product selection you will be issued with a seven character Golledge part number. Your Golledge part number is the internationally accepted Golledge manufacturing part number (MPN) that should be used for all project documentation, including bills of materials (BoMs) and purchase orders.

If you have any queries regarding any of our documentation our dedicated sales team will be happy to help.

MARKING

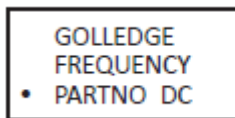

- Pin 1 Marking type: Laser

DC = Date Code in YM, eg. "GF" = Jun 2017

	A	B	C	D	E	F	G	H	J	K	L	M
Y	1	2	3	4	5	6	7	8	9	0		
M	Jan	Feb	Mar	Apr	May	Jun	Jul	Aug	Sep	Oct	Nov	Dec

ENABLE / DISABLE FUNCTION

Input (pad 1)	Output 1 (pad 4)	Output 2 (pad 5)
Open	Enabled	Enabled
'1' level ($\geq 0.7 V_{DD}$)	Enabled	Enabled
'0' level ($\leq 0.3 V_{DD}$)	High Impedance	High Impedance

SOLDERING PROFILE

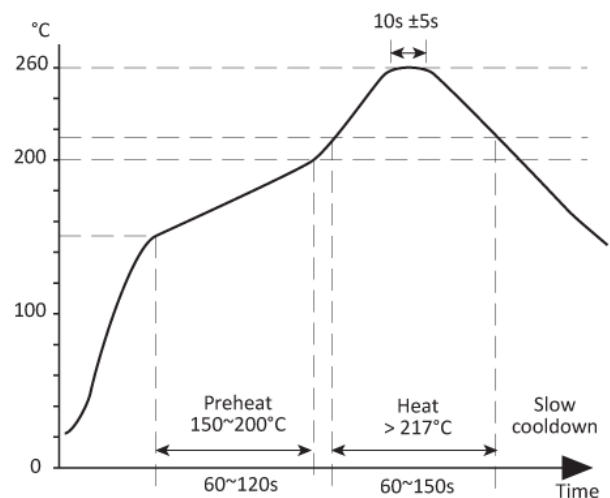

Lead free solderability limits: 260°C ±5°C x 10s ±5s x 2.

TAPE & REEL SPECIFICATION

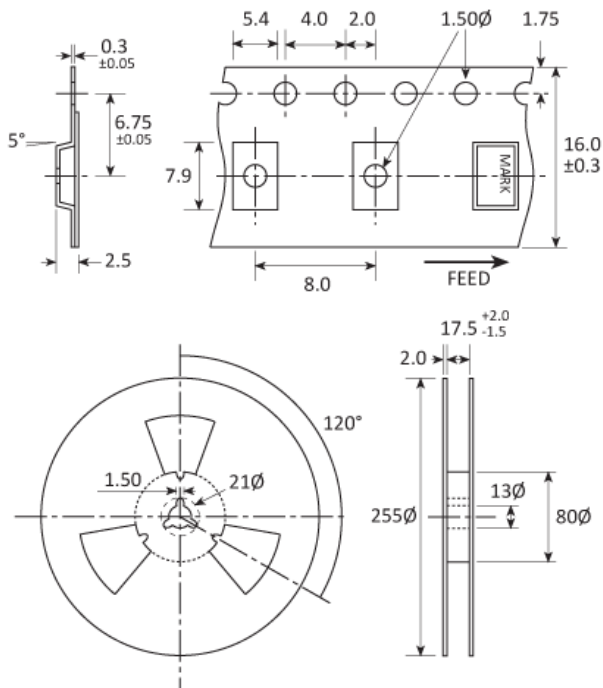

Dimensions in mm

CONSTRUCTION

Ceramic body with gold-plated pads
Metal lid, seam sealed

HANDLING & STORAGE



Human Body Model (HBM) 1A (250V to <500V)



Moisture Sensitivity Level (MSL): 1 (or not applicable)

COMPLIANCE

Please refer to our **DOCUMENTS** section for more information.



Lead-free (< 0.1% by weight)



RoHS compliant with no exemptions.



REACH compliant.



Free of conflict minerals.



Free from halogens.



Free from ozone-depleting substances.